

EXPORT EQUIPMENT CATALOGUE

TYRE CHANGERS AND ORIGINAL ACCESSORIES EFFECTIVE FROM MARCH 2026



automotive service equipment

REL. MARCH 2026

ORDERS OF SPARE PARTS

Spare parts orders having an amount below EUR 100,00 and which are to be sent separately from a shipment of machines, will be charged of an administrative fee of EUR 30,00.

COLOR TABLE

STANDARD COLORS:

| | |
|----------|-----------|
| RAL 3002 | Red |
| RAL 7016 | Dark Grey |

NON-STANDARD COLORS:

| | |
|----------|------------|
| RAL 3000 | Red |
| RAL 7015 | Grey |
| RAL 7011 | Grey |
| RAL 7012 | Grey |
| RAL 7040 | Grey |
| RAL 7030 | Grey |
| RAL 5011 | Blue |
| RAL 1003 | Yellow |
| RAL 7042 | Grey |
| RAL 9005 | Black |
| RAL 5015 | Blue |
| RAL 9006 | Light Grey |
| RAL 1007 | Yellow |

Non-standard colors require following gross price surcharge:

The surcharge does not apply to orders of minimum 5 units of the same model.
Color customization refers to the main carpentry parts that identify the product's color, it does not include any plastic parts.

Nexion SpA reserves the right to change the specifications of its products at any time without prior notice. The company declines all responsibility in the event of claims deriving from the use of non-original accessories or spare parts with consequent forfeiture of the EC declaration of conformity.

SUMMARY

LIGHT TYRE CHANGERS MOTORCYCLE

| | |
|---|----|
| AS905 MOTORBIKE | 4 |
| ACCESSORIES FOR AS905 MOTORBIKE | 4 |
| TRADITIONAL CAR TYRE CHANGERS | 5 |
| AQUILA AS905 SERIES | 6 |
| AQUILA AS914 SERIES | 6 |
| AQUILA TWISTER | 7 |
| AQUILA AS922 SERIES | 8 |
| AQUILA AS924 SERIES | 9 |
| AQUILA AS924 A SERIES | 10 |
| AQUILA AS934 SERIES | 11 |
| AQUILA AS943 SERIES | 12 |
| AQUILA AS944 SERIES | 13 |
| AQUILA AS946 SERIES | 14 |
| ACCESSORIES FOR CAR TYRE CHANGERS (AND AS 944 LL) | 15 |

“WITHOUT LEVER” CAR TYRE CHANGERS

| | |
|---|----|
| AQUILA AS944 LL | 27 |
| AQUILA AUDAX | 27 |
| AQUILA RAPTOR | 28 |
| AQUILA RAPAX | 29 |
| AQUILA TORNADO SERIES | 30 |
| “WITHOUT LEVER” TYRE CHANGER FOR SERVICE MOBILE | 31 |
| AQUILA AUDAX M | 32 |
| “WITHOUT LEVER” TYRE CHANGER ACCESSORIES | 33 |

SEMI-AUTOMATIC HEAVY-DUTY TYRE CHANGER

| | |
|--------------|----|
| TB120 | 41 |
| TB125 | 42 |
| TB128 N | 43 |
| TBE 145 N | 44 |
| TBE155 | 45 |
| TBE156 N PRO | 46 |

AUTOMATIC HEAVY-DUTY TYRE CHANGER

| | |
|----------------------|----|
| TB128 DELUXE - SUPER | 47 |
| TBE145 S | 48 |
| TBE155 S | 49 |
| TBE156 DELUXE-S PRO | 50 |
| TBE160 TERRA | 51 |
| TBE60 TERRA | 52 |

SUPER AUTOMATIC “WITHOUT LEVER” HEAVY-DUTY TYRE CHANGERS

| | |
|--------------|----|
| TBE160 MATIC | 53 |
|--------------|----|

HEAVY-DUTY TYRE CHANGER FOR MOBILE SERVICE

| | |
|--|----|
| TB124 MOBILE | 54 |
| TB123 MOBILE | 55 |
| TMW 20 S | 56 |
| ACCESSORIES FOR HEAVY-DUTY TYRE CHANGERS | 57 |

LIGHT TYRE CHANGERS MOTORCYCLE

AS905 MOTORBIKE



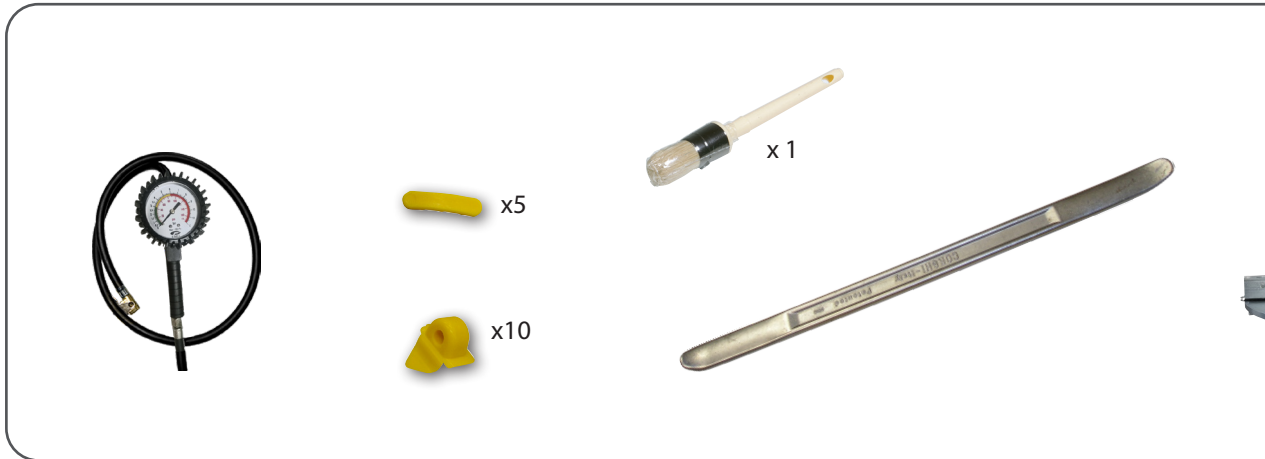

4"-26"

STANDARD ACCESSORIES



| Part-no | Electrical Supply | Description | |
|---------------|-------------------|------------------------|--|
| 0-11311201/16 | 400V/3Ph/50Hz | AS905 MOTORBIKE | |
| 0-11311202/16 | 230V/3Ph/50Hz | AS905 MOTORBIKE | |
| 0-11311203/16 | 230V/1Ph/50Hz | AS905 MOTORBIKE | |
| 0-11311204/16 | 230V/1Ph/60Hz | AS905 MOTORBIKE | |
| 0-11311205/16 | 115V/1Ph/60Hz | AS905 MOTORBIKE | |

ACCESSORIES FOR AS905 MOTORBIKE

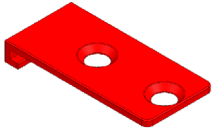
| Image | Part-no | Description | |
|---|------------|---|--|
|  | 8-11100461 | Racing bike turntable jaw kit 8" – 26" | |
|  | 8-11100462 | ATV turntable jaw kit 5"-18" | |
|  | 8-11100463 | Removable platform for bike wheels | |
|  | 8-11100476 | Motorcycle grip Protection Kit (8 pz.) | |

MORE ACCESSORIES FOR MODEL AS905 MOTORBIKE ARE AVAILABLE IN THE CAR TYRE CHANGER ACCESSORIES SECTION

TRADITIONAL CAR TYRE CHANGERS

AQUILA AS905 SERIES



13"-25"



11"-22"

STANDARD ACCESSORIES



| Part-no | Electrical Supply | Description |
|---------------|-------------------|---------------------------|
| 0-11301501/16 | 400V/3Ph/50Hz | AS905 22" |
| 0-11301502/16 | 230V/1Ph/50Hz | AS905 22" |
| 0-11301512/16 | 230V/1Ph/60Hz | AS905 22" |
| 0-11301504/16 | 110V/1Ph/60Hz | AS905 22" |
| 0-11301601/16 | 400V/3Ph/60Hz | AS905 TI 22" |
| 0-11301631/16 | 200-230V/3Ph/60Hz | AS905 TI 22" |
| 0-11301612/16 | 230V/1Ph/60Hz | AS905 TI 22" |
| 0-11301613/16 | 230V/1Ph/50Hz | AS905 TI 22" |
| 0-11301604/16 | 110V/1Ph/60Hz | AS905 TI 22" |
| 0-11301506/16 | 12 VOLTS | AS905 22" 12 Volts |

TRADITIONAL CAR TYRE CHANGERS

AQUILA AS914 SERIES



13"-26"



10"-24"

STANDARD ACCESSORIES

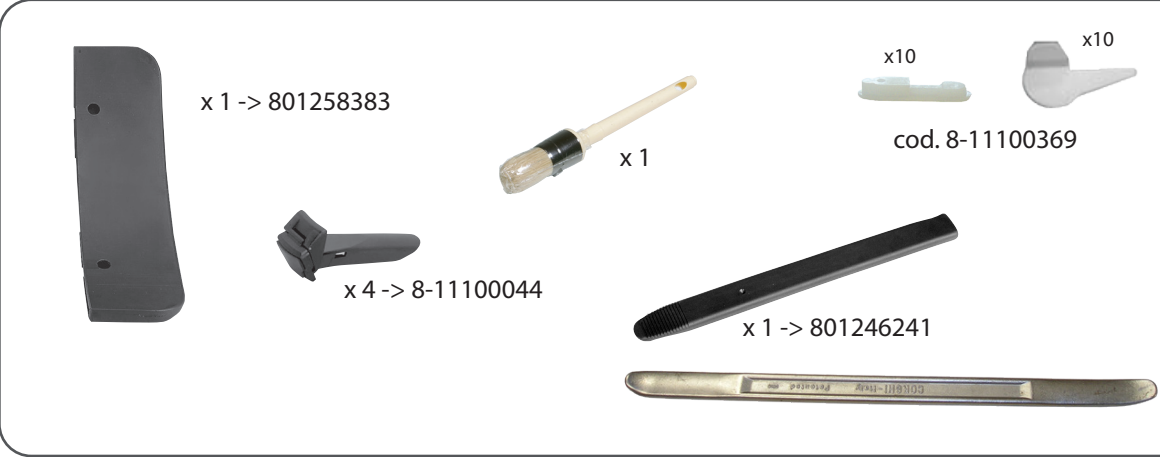

| Part-no | Electrical Supply | Description |
|---------------|-------------------|--------------------|
| 0-11106234/16 | 115V/1Ph/60Hz | AS914 TI MI |



NEW

TRADITIONAL CAR TYRE CHANGERS

AQUILA TWISTER

STANDARD ACCESSORIES



13"-26"



10"-24"

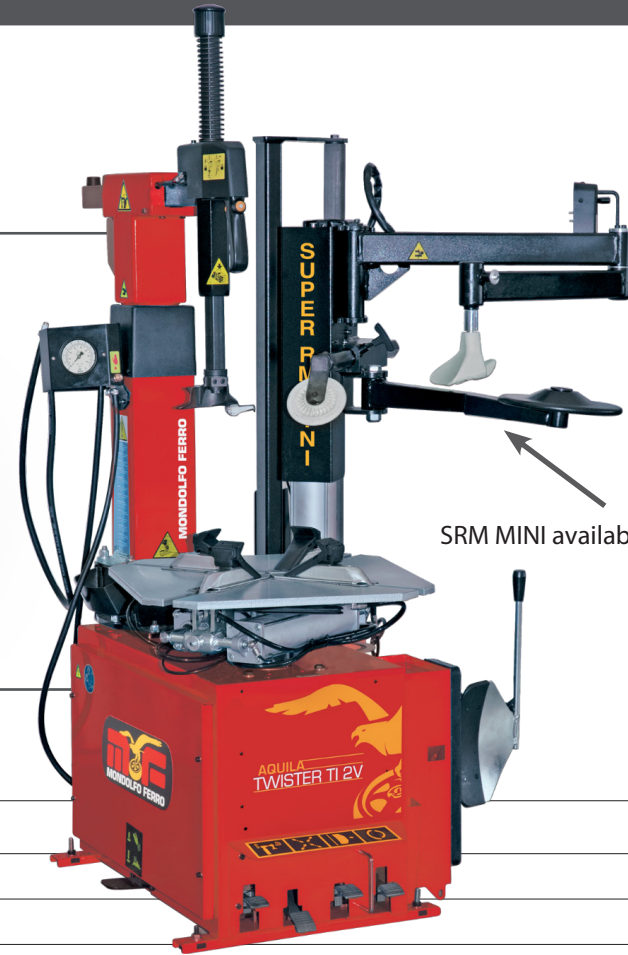

SRM MINI available on request

| Part-no | Electrical Supply | Description |
|--|-----------------------|------------------------------------|
| 0-11311001/16 | 400V/3Ph/50Hz | Aquila TWISTER 24" |
| 0-11311002/16 | 200-230V/1Ph/50-60Hz | Aquila TWISTER 24" 2V MI |
| 0-11311101/16 | 400V/3Ph/50Hz | Aquila TWISTER 24" TI |
| 0-11311102/16 | 200-230V/1Ph/50-60Hz | Aquila TWISTER 24" TI 2V MI |
| 0-11311112/16 | 200-230V/1Ph/50Hz | Aquila TWISTER 24" TI |
| 0-11311122/16 | 200-230V/1Ph/60Hz | Aquila TWISTER 24" TI |
| 0-11311006/16 | 12 Volt | Aquila TWISTER 24" 12V |
| Versions with pneumatic tools positioning | | |
| 0-11311302/16 | 200-230V/1Ph/ 50-60Hz | Aquila TWISTER 24" 2V MI |
| 0-11311402/16 | 200-230V/1Ph/ 50-60Hz | Aquila TWISTER 24" TI 2V MI |

TRADITIONAL CAR TYRE CHANGERS

AQUILA AS922 SERIES

STANDARD ACCESSORIES



for NO TI versions only



x5

cod.
8-11100107



x10

cod.
8-11100106



13"-25"



11"-22"



| Part-no | Electrical Supply | Description |
|---------------|----------------------|---------------------------|
| 0-11302701/16 | 400V/3Ph/50Hz | AS922 22" |
| 0-11302702/16 | 230V/1Ph/50Hz | AS922 22" |
| 0-11302711/16 | 200-230V/3Ph/60Hz | AS922 22" |
| 0-11302712/16 | 230V/1Ph/60Hz | AS922 22" |
| 0-11302761/16 | 115V/1Ph/60Hz | AS922 22" |
| 0-11302741/16 | 400V/3Ph/50Hz | AS922 22" 2V |
| 0-11302751/16 | 200-230V/3Ph/60Hz | AS922 22" 2V |
| 0-11302732/16 | 200-230V/1Ph/50-60Hz | AS922 22" 2V MI |
| 0-11302601/16 | 400V/3Ph/50Hz | AS922 22" TI |
| 0-11302602/16 | 230V/1Ph/50Hz | AS922 22" TI |
| 0-11302611/16 | 200-230V/3Ph/60Hz | AS922 22" TI |
| 0-11302612/16 | 230V/1Ph/60Hz | AS922 22" TI |
| 0-11302621/16 | 200-230V/3Ph/60Hz | AS922 22" TI KPA |
| 0-11302632/16 | 200-230V/1Ph/50-60Hz | AS922 22" TI 2V MI |
| 0-11302641/16 | 400V/3Ph/50Hz | AS922 22" TI 2V |
| 0-11302651/16 | 200-230V/3Ph/60Hz | AS922 22" TI 2V |

TRADITIONAL CAR TYRE CHANGERS

AQUILA AS924 SERIES



13"-26"



10"-24"

STANDARD ACCESSORIES

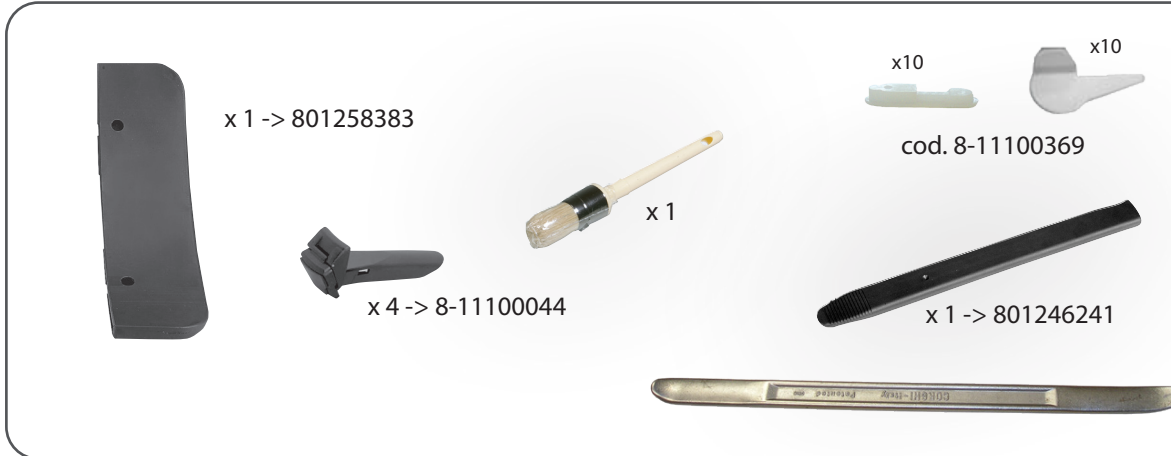

| Part-no | Electrical Supply | Description |
|---------------|-------------------|------------------------|
| 0-11301001/16 | 400V/3Ph/50Hz | AS924 24" |
| 0-11301002/16 | 230V/1Ph/50Hz | AS924 24" |
| 0-11301041/16 | 400V/3Ph/50Hz | AS924 24" 2V |
| 0-11301022/16 | 200-230V/1Ph/50Hz | AS924 24" 2V MI |
| 0-11301102/16 | 230V/1Ph/50Hz | AS924 TI 24" |
| 0-11301132/16 | 200-230V/1Ph/50Hz | AS924 TI 24" 2V |
| 0-11301141/16 | 400V/3Ph/50Hz | AS924 TI 24" 2V |

TRADITIONAL CAR TYRE CHANGERS

AQUILA AS924 A SERIES



13"-26"



10"-24"



STANDARD ACCESSORIES



x 1 -> 801258383



x 4 -> 8-11100044



x 1



x10



x10

cod. 8-11100369



x 1 -> 801246241



| Part-no | Electrical Supply | Description | |
|---------------|----------------------|----------------------|--|
| 0-11302841/16 | 400V/3Ph/50Hz | AS924 A 24" 2V | |
| 0-11302932/16 | 200-230V/1Ph/50-60Hz | AS924 A 24" TI 2V MI | |

TRADITIONAL CAR TYRE CHANGERS

AQUILA AS934 SERIES



13"-23"



10"-20"

STANDARD ACCESSORIES



x 1 -> 801258383



x 4 -> 8-11100044



x 1

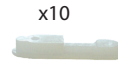

x10



x10

cod. 8-11100369



x 1 -> 801246241



AVAILABLE UNTIL STOCKS LAST

| Part-no | Electrical Supply | Description | |
|---------------|-------------------|--------------------|--|
| 0-11301201/16 | 400V/3Ph/50Hz | AS934 | |
| 0-11301202/16 | 230V/1Ph/50Hz | AS934 | |
| 0-11301232/16 | 230V/1Ph/50-60Hz | AS934 2V | |
| 0-11301332/16 | 230V/1Ph/50-60Hz | AS934 TI 2V | |

TRADITIONAL CAR TYRE CHANGERS

AQUILA AS943 SERIES



13"-25"



10"-22"

STANDARD ACCESSORIES



x 1 -> 801258383



x 4 -> 8-11100044



x 1



x10



x10

cod. 8-11100369



x 1 -> 801246241



| Part-no | Electrical Supply | Description | |
|---------------|----------------------|---|--|
| 0-11105501/16 | 400V/3Ph/50Hz | AS943 | |
| 0-11105502/16 | 230V/1Ph/50Hz | AS943 | |
| 0-11105532/16 | 230V/1Ph/50-60Hz | AS943 2V | |
| 0-11105601/16 | 200-230V/1Ph/50-60Hz | AS943 TI 2V | |
| 0-11105602/16 | 230V/1Ph/50Hz | AS943 TI | |
| 0-11105611/16 | 400V/3Ph/50Hz | AS943 TI | |
| 0-11105622/16 | 200-230V/1Ph/50-60Hz | AS943 TI 2V complete of SUPER RM NEW, RM2, RM3 and WDK kit | |

TRADITIONAL CAR TYRE CHANGERS

AQUILA AS944 SERIES



13''-26''



10''-24''

STANDARD ACCESSORIES



x 1 -> 801258383



x 4 -> 8-11100044



x 1



x10

x10

cod. 8-11100369



x 1 -> 801246241

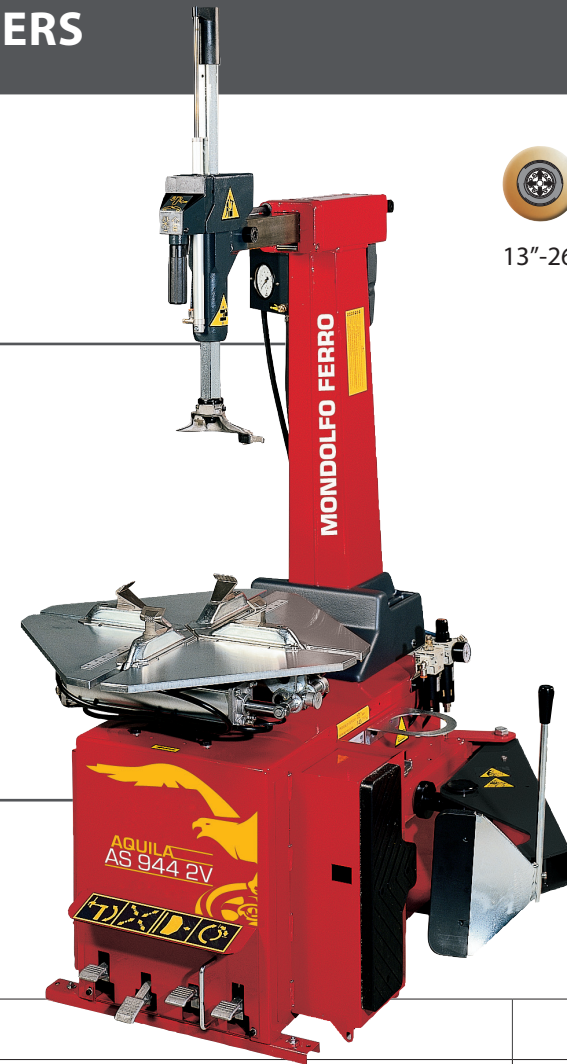

| Part-no | Electrical Supply | Description | |
|---------------|----------------------|---|--|
| 0-11105701/16 | 400V/3Ph/50Hz | AS944 | |
| 0-11105702/16 | 230V/1Ph/50Hz | AS944 | |
| 0-11105732/16 | 230V/1Ph/50-60Hz | AS944 2V | |
| 0-11105801/16 | 200-230V/1Ph/50Hz | AS944 TI 2V | |
| 0-11105802/16 | 230V/1Ph/50Hz | AS944 TI | |
| 0-11105811/16 | 400V/3Ph/50Hz | AS944 TI | |
| 0-11105822/16 | 200-230V/1Ph/50-60Hz | AS944 TI 2V complete of SUPER RM NEW, RM2, RM3 and WDK kit | |

TRADITIONAL CAR TYRE CHANGERS

AQUILA AS946 SERIES



13"-28"



10"-26"

STANDARD ACCESSORIES

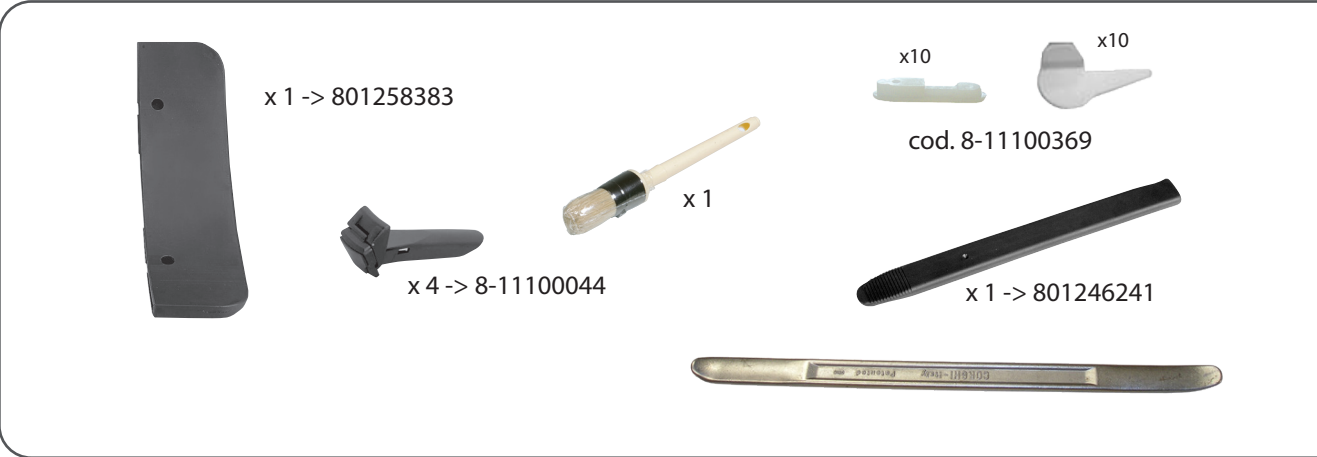





| Part-no | Electrical Supply | Description |
|---------------|----------------------|---|
| 0-11107232/16 | 200-230V/1Ph/50-60Hz | AS946 TI 2V |
| 0-11107222/16 | 200-230V/1Ph/50-60Hz | AS946 TI 2V complete of SUPER RM NEW, RM2, RM3 and WDK kit |



NEW



ACCESSORIES FOR CAR TYRE CHANGERS (AND AS 944 LL)

| Image | Part-no | Description | AS 905 MOTORBIKE | AS 905 | AS 914 TI | TWISTER | AS 922 | AS 924 | AS 924 A | AS 933 | AS 934 | AS 943 | AS 944 | AS 944 LL | AS 946 | AS 963 |
|---|------------|--|------------------|--------|-----------|---------|--------|--------|----------|--------|--------|--------|--------|-----------|--------|--------|
| TYRE PRESSURE MONITORING SYSTEMS | | | | | | | | | | | | | | | | |
|  | 6015001300 | TPM-02 - Portable device for TPMS sensor | | ★ | ★ | ★ | ★ | ★ | ★ | ★ | ★ | ★ | ★ | ★ | ★ | ★ |
|  | 8-64500013 | Kit OBD | | ★ | ★ | ★ | ★ | ★ | ★ | ★ | ★ | ★ | ★ | ★ | ★ | ★ |
|  | 6015001391 | TPM-02 PLUS (OBD kit included) | | ★ | ★ | ★ | ★ | ★ | ★ | ★ | ★ | ★ | ★ | ★ | ★ | ★ |
|  | 8-51100029 | Subscription 12 months TPM-02 Standard | | ★ | ★ | ★ | ★ | ★ | ★ | ★ | ★ | ★ | ★ | ★ | ★ | ★ |
| | 8-51120003 | Subscription 12 months TPM-02 Extended | | ★ | ★ | ★ | ★ | ★ | ★ | ★ | ★ | ★ | ★ | ★ | ★ | ★ |
| | 8-51120001 | Subscription 12 months TPM-02 PLUS Standard | | ★ | ★ | ★ | ★ | ★ | ★ | ★ | ★ | ★ | ★ | ★ | ★ | ★ |
| | 8-51120004 | Subscription 12 months TPM-02 PLUS Extended | | ★ | ★ | ★ | ★ | ★ | ★ | ★ | ★ | ★ | ★ | ★ | ★ | ★ |
|  | 6015001360 | Bluetooth printer | | ★ | ★ | ★ | ★ | ★ | ★ | ★ | ★ | ★ | ★ | ★ | ★ | ★ |

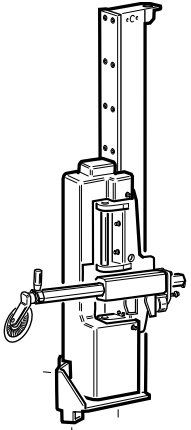
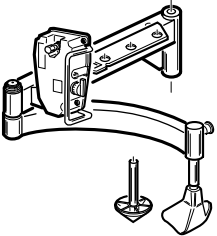
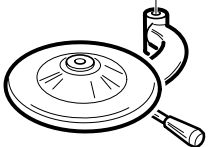

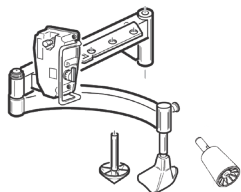

ACCESSORIES FOR CAR TYRE CHANGERS (AND AS 944 LL)

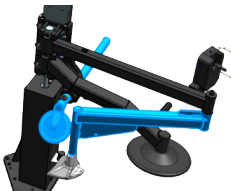
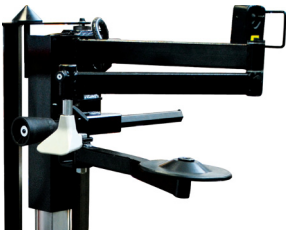
| Image | Part-no | Description | | AS 905 MOTORBIKE | AS 905 | AS 914TI | TWISTER | AS 922 | AS 924 | AS 924 A | AS 933 | AS 934 | AS 943 | AS 944 | AS 944 LL | AS 946 |
|---|------------|---|--|------------------|--------|----------|---------|--------|--------|----------|--------|--------|--------|--------|-----------|--------|
| BEAD PRESSING SYSTEMS | | | | | | | | | | | | | | | | |
|  | 8-11120097 | SUPER RM New - Power unit for Super RM device including 1 o'clock bead pressure device and 2 RM supports | | | | | ★ | | | ★ | ★ | ★ | ★ | ★ | ★ | ★ |
|  | 8-11100181 | Kit RM2 - Mobile bead pressure device to be combined with power unit P/N 8-11120097 | | | | ★ | | | | ★ | ★ | ★ | ★ | ★ | ★ | ★ |
| IMAGE NOT AVAILABLE | 8-11100153 | Extension road and cone for reverse rim for RM2 | | | | ★ | | | | ★ | ★ | ★ | ★ | ★ | ★ | ★ |
|  | 8-11100183 | Kit RM3 - Bead lifter to be combined with power unit P/N 8-11120097 | | | | ★ | | | | ★ | ★ | ★ | ★ | ★ | ★ | ★ |



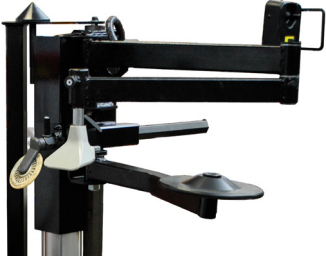

ACCESSORIES FOR CAR TYRE CHANGERS (AND AS 944 LL)

| Image | Part-no | Description | AS 905 MOTORBIKE | AS 905 | AS 914TI | TWISTER | AS 922 | AS 924 | AS 924 A | AS 933 | AS 934 | AS 943 | AS 944 | AS 944 LL | AS 946 |
|---|---------------|---|------------------|--------|----------|---------|--------|--------|----------|--------|--------|--------|--------|-----------|--------|
| BEAD PRESSING SYSTEMS | | | | | | | | | | | | | | | |
|  | 8-11100238/00 | Kit RM2 EAGLE - Mobile bead pressure device with conical roller to be combined with power unit P/N 8-11120097. To use conical roller instead of disc on 1 o'clock bead pressure device | | | | ★ | | | | ★ | ★ | ★ | ★ | ★ | ★ |
|  | 8-11100343 | SRM 300 - Universal multifunctional device | | | | ★ | ★ | ★ | ★ | ★ | ★ | ★ | ★ | ★ | ★ |
| | 8-11100346 | Customization kit | | | | ★ | | | | ★ | ★ | ★ | ★ | ★ | ★ |
| | 8-11300050 | Customization kit | | | | | | ★ | ★ | | | | | | |
| | 8-11320006 | Customization kit | | | | | ★ | | | | | | | | |
|  | 8-11120096 | KIT roller to disk for HELPER 8-11100343 | | | | ★ | ★ | ★ | ★ | ★ | ★ | ★ | ★ | ★ | ★ |
|  | 8-11320008 | SRM MINI multifunctional helper | | | | | ★ | | | | | | | | |
| | 8-11300042 | SRM MINI multifunctional helper | | | | | | ★ | ★ | | | | | | |
| | 8-11100450 | SRM MINI Multifunctional helper, roller version | | | ★ | ★ | | | | ★ | ★ | ★ | ★ | ★ | ★ |





ACCESSORIES FOR CAR TYRE CHANGERS (AND AS 944 LL)

| Image | Part-no | Description | | AS 905 MOTORBIKE | AS 905 | AS 914TI | TWISTER | AS 922 | AS 924 | AS 924 A | AS 933 | AS 934 | AS 943 | AS 944 | AS 944 LL | AS 946 |
|---|------------|--|--|------------------|--------|----------|---------|--------|--------|----------|--------|--------|--------|--------|-----------|--------|
| BEAD PRESSING SYSTEMS | | | | | | | | | | | | | | | | |
|  | 8-11100451 | SRM MINI Multifunctional helper, disc version | | | | ★ | ★ | | | | ★ | ★ | ★ | ★ | ★ | ★ |
|  | 8-11100399 | Helper SX 1 for AS 914 | | | | ★ | | | | | | | | | | |
|  | 8-11320005 | Customization kit for SX1 for A914 | | | | ★ | | | | | | | | | | |
|  | 8-11120032 | BLP SX - Helper for AS905 | | ★ | ★ | | | ★ | ★ | ★ | | | | | | |









ACCESSORIES FOR CAR TYRE CHANGERS (AND AS 944 LL)

| Image | Part-no | Description | | AS 905 MOTORBIKE | AS 905 | AS 914TI | TWISTER | AS 922 | AS 924 | AS 924 A | AS 933 | AS 934 | AS 943 | AS 944 | AS 944 LL | AS 946 | AS 963 |
|---|------------|--|--|------------------|--------|----------|---------|--------|--------|----------|--------|--------|--------|--------|-----------|--------|--------|
| BEAD PRESSING SYSTEMS | | | | | | | | | | | | | | | | | |
|  | 8-11100027 | RPX - Power unit for help device to be fixed on the left hand side of the machine, to be combined with P/N 8-11100066 | | | | ★ | | | | | | | | | | | |
|  | 8-11100066 | Support to mount the RPX on swing arm passenger car tyre changers to be combined with P/N 8-11100027 | | | | ★ | | | | | | | | | | | |
|  | 8-11100293 | BPA - Mobile bead pressure device and disc bead lifter to be combined with P/N 8-11100027 | | | | ★ | | | | | | | | | | | |
|  | 8-11400290 | PTR - Roller bead pressing tool | | | | | ★ | ★ | ★ | | ★ | ★ | ★ | ★ | ★ | ★ | ★ |









ACCESSORIES FOR CAR TYRE CHANGERS (AND AS 944 LL)

| | Part-no | Description | AS 905 MOTORBIKE | AS 905 | AS 914TI | TWISTER | AS 922 | AS 924 | AS 924 A | AS 933 | AS 934 | AS 943 | AS 944 | AS 944 LL | AS 946 | AS 963 |
|--|------------|--|------------------|--------|----------|---------|--------|--------|----------|--------|--------|--------|--------|-----------|--------|--------|
| KITS WDK | | | | | | | | | | | | | | | | |
|  | 19110064 | Bead breaker stroke limiter | | | | ★ | | | | ★ | ★ | | | | | |
| JAWS ADAPTORS | | | | | | | | | | | | | | | | |
|  x4 | 8-11100036 | Set of 4 motorcycle adaptors | | ★ | ★ | ★ | ★ | ★ | ★ | ★ | ★ | ★ | ★ | ★ | ★ | ★ |
|  x4 | 8-11100041 | Set of 4 adaptors for increasing outside locking of 4". | | ★ | ★ | ★ | ★ | ★ | ★ | ★ | ★ | ★ | ★ | ★ | ★ | ★ |
|  x4 | 8-11100042 | Set of 4 adaptors for 8-9" rims (it can lock from outside rims up to 6"). | | ★ | ★ | ★ | ★ | ★ | ★ | ★ | ★ | ★ | ★ | ★ | ★ | ★ |







ACCESSORIES FOR CAR TYRE CHANGERS (AND AS 944 LL)

| Image | Part-no | Description | AS 905 MOTORBIKE | AS 905 | AS 914TI | TWISTER | AS 922 | AS 924 | AS 924 A | AS 933 | AS 934 | AS 943 | AS 944 | AS 944 LL | AS 946 | AS 963 |
|---|------------|--|--------------------------|--------------------------|--------------------------|--------------------------|--------------------------|--------------------------|--------------------------|--------------------------|--------------------------|--------------------------|--------------------------|-----------|--------------------------|--------------------------|
| Plastic protectionons | | | | | | | | | | | | | | | | |
|  | 801258898 | Kit of 5 pieces of bottom plastic inserts for steel mounting tool | <input type="checkbox"/> | | ★ | ★ | | ★ | ★ | ★ | ★ | ★ | ★ | | ★ | ★ |
|  | 801254341 | Kit of 10 pieces of front plastic inserts for mounting tool | <input type="checkbox"/> | | ★ | ★ | | ★ | ★ | ★ | ★ | ★ | ★ | | ★ | ★ |
|  | 8-11100045 | Kit of 10 pieces of front plastic inserts for RS mounting tool | ★ | ★ | ★ | | ★ | ★ | ★ | ★ | ★ | ★ | ★ | | ★ | ★ |
|  | 801246241 | Kit of 6 pieces of plastic protectors for tyre lever | ★ | ★ | <input type="checkbox"/> | <input type="checkbox"/> | ★ | <input type="checkbox"/> | <input type="checkbox"/> | <input type="checkbox"/> | <input type="checkbox"/> | <input type="checkbox"/> | <input type="checkbox"/> | | <input type="checkbox"/> | <input type="checkbox"/> |
|  | 8-11100044 | Kit of 12 jaws of plastic protections (inside and outside) for alloy rims | | ★ | <input type="checkbox"/> | <input type="checkbox"/> | ★ | <input type="checkbox"/> | <input type="checkbox"/> | <input type="checkbox"/> | <input type="checkbox"/> | <input type="checkbox"/> | <input type="checkbox"/> | | <input type="checkbox"/> | <input type="checkbox"/> |
|  | 801258383 | Kit of 6 pieces of bead breaker blade plastic protectors | | ★ | <input type="checkbox"/> | <input type="checkbox"/> | ★ | <input type="checkbox"/> | <input type="checkbox"/> | <input type="checkbox"/> | <input type="checkbox"/> | <input type="checkbox"/> | <input type="checkbox"/> | | <input type="checkbox"/> | <input type="checkbox"/> |
|  | 801458663 | Plastic protection for bead breaker pad (1 pcs) | ★ | ★ | | | ★ | ★ | ★ | | | | | | | |
| x10  | 8-11100106 | Kit of 10 front tool head protectors | | <input type="checkbox"/> | | | <input type="checkbox"/> | | | | | | | | | |









ACCESSORIES FOR CAR TYRE CHANGERS (AND AS 944 LL)

| Image | Part-no | Description | AS 905 MOTORBIKE | AS 905 | AS 914TI | TWISTER | AS 922 | AS 924 | AS 924 A | AS 933 | AS 934 | AS 943 | AS 944 | AS 944 LL | AS 946 | AS 963 |
|---|------------|--|------------------|--------------------------|----------|---------|--------------------------|--------|----------|--------|--------|--------|--------|--------------------------|--------|--------|
|  x5 | 8-11100107 | Kit of 10 front tool head protectors | | <input type="checkbox"/> | | | <input type="checkbox"/> | | | | | | | | | |
|  x3 | 8-11120014 | REP - Rim edge plastic protections (yellow) | ★ | ★ | ★ | ★ | ★ | ★ | ★ | ★ | ★ | ★ | ★ | <input type="checkbox"/> | ★ | ★ |
|  x3 | 8-11120015 | REPS - Short rim edge plastic protections (yellow) | ★ | ★ | ★ | ★ | ★ | ★ | ★ | ★ | ★ | ★ | ★ | ★ | ★ | ★ |
|  | 801461007 | Plastic protection for rim edge (3 pieces) | ★ | ★ | ★ | ★ | ★ | ★ | ★ | ★ | ★ | ★ | ★ | ★ | ★ | ★ |
|  x5 | 8-11400293 | Spare kit of leverless tool head plastic protections (up to serial number MMG143250) | | | | | | | | | | | | <input type="checkbox"/> | | |
|  x10 | 8-11400325 | Plastic protections kit for "without lever" V3 head tool (from serial number MMG143251) | | | | | | | | | | | | <input type="checkbox"/> | | |
|  | 8-11120013 | PTS - protezione tallone (colore rosso) | | | | | | | | | | | | <input type="checkbox"/> | | |
|  | 801461005 | Valve core screw driver car/truck (1 piece) | ★ | ★ | ★ | ★ | ★ | ★ | ★ | ★ | ★ | ★ | ★ | ★ | ★ | ★ |
|  | 801461004 | Valve inserting lever | ★ | ★ | ★ | ★ | ★ | ★ | ★ | ★ | ★ | ★ | ★ | ★ | ★ | ★ |









ACCESSORIES FOR CAR TYRE CHANGERS (AND AS 944 LL)

| Image | Part-no | Description | | | | | | | | | | | | | | |
|---|------------|---|------------------|--------|----------|---------|--------|--------|----------|--------|--------|--------|--------|-----------|--------|--------|
| | | | AS 905 MOTORBIKE | AS 905 | AS 914TI | TWISTER | AS 922 | AS 924 | AS 924 A | AS 933 | AS 934 | AS 943 | AS 944 | AS 944 LL | AS 946 | AS 963 |
| MISCELLANEOUS | | | | | | | | | | | | | | | | |
|  | 8-11600126 | IG.P inflating gun CE Approved | ★ | ★ | | | ★ | | | | | | | | | |
| | 8-51120007 | ASTURO BAR/PSI inflating gun | | | | | | | ★ | | | | | | | |
|  | 8-11100353 | SLPR80 A - Wheel lifter with roller | | | ★ | ★ | | | | ★ | ★ | ★ | ★ | ★ | ★ | |
|  | 8-11100292 | SL80 A - Wheel lifter | | | ★ | ★ | | | | ★ | ★ | ★ | ★ | ★ | ★ | |
|  | 8-11320007 | SL60 A - Wheel lifter | ★ | | | | | ★ | ★ | ★ | | | | | | |
|  | 8-11900276 | RWL Kit – Roller Wheel Lifter 70 | ★ | ★ | ★ | ★ | ★ | ★ | ★ | ★ | ★ | ★ | ★ | ★ | ★ | |
|  | 8-11100312 | Platform roller | | | ★ | ★ | | | | ★ | ★ | ★ | ★ | ★ | | |
|  | 801435685 | Plastic clamp for STANDARD type alloy rims | ★ | ★ | ★ | ★ | ★ | ★ | ★ | ★ | ★ | ★ | ★ | ★ | ★ | |

ACCESSORIES FOR CAR TYRE CHANGERS (AND AS 944 LL)

| Image | Part-no | Description | AS 905 MOTORBIKE | AS 905 | AS 914TI | TWISTER | AS 922 | AS 924 | AS 924 A | AS 933 | AS 934 | AS 943 | AS 944 | AS 944 LL | AS 946 | AS 963 |
|---|------------|--|------------------|--------|----------|---------|--------|--------|----------|--------|--------|--------|--------|-----------|--------|--------|
| MISCELLANEOUS | | | | | | | | | | | | | | | | |
|  | 801262417 | Plastic clamp for SOFT LINE type alloy rims | ★ | ★ | ★ | ★ | ★ | ★ | ★ | ★ | ★ | ★ | ★ | □ | ★ | ★ |
|  | 8-11120050 | TAM/WING Steel tool head for cars and motorcycles (starting from serial # MRC197168 from April 2021 onward) | ★ | ★ | ★ | □ | ★ | □ | □ | □ | □ | □ | □ | □ | □ | ★ |
|  | 8-11100369 | Tool Head protection kit | ★ | ★ | ★ | □ | ★ | □ | □ | □ | □ | □ | □ | □ | □ | ★ |
|  | 8-11400329 | TPA/WING Full assembly plastic tool-head kit with adapter (starting from serial #MRC197168) | ★ | ★ | ★ | ★ | ★ | ★ | ★ | ★ | ★ | ★ | ★ | | ★ | ★ |
|  | 8-11400334 | TPA/WING Full assembly plastic tool-head kit with adapter (before serial #MRC197168) | ★ | ★ | ★ | ★ | ★ | ★ | ★ | ★ | ★ | ★ | ★ | | ★ | ★ |
|  | 8-11400330 | TPA/WING Single plastic tool-head | ★ | ★ | ★ | ★ | ★ | ★ | ★ | ★ | ★ | ★ | ★ | | ★ | ★ |
|  | 8-11100378 | TMN Mounting/demounting tool head for scooter wheels. Complete with plastic alloy rim protections (starting from serial #MRC197168) | ★ | ★ | ★ | ★ | ★ | ★ | ★ | ★ | ★ | ★ | ★ | | ★ | ★ |
|  | 8-11100370 | MPK6 Protection kit for new scooters m/d head (for TMN scooter) | ★ | ★ | ★ | ★ | ★ | ★ | ★ | ★ | ★ | ★ | ★ | | ★ | ★ |

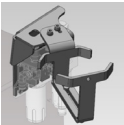
ACCESSORIES FOR CAR TYRE CHANGERS (AND AS 944 LL)

| Image | Part-no | Description | ACCESSORIES FOR CAR TYRE CHANGERS (AND AS 944 LL) | | | | | | | | | | | | | |
|---|------------|--|---|--------|----------|---------|--------|--------|----------|--------|--------|--------|--------|-----------|--------|--------|
| | | | AS 905 MOTORBIKE | AS 905 | AS 914TI | TWISTER | AS 922 | AS 924 | AS 924 A | AS 933 | AS 934 | AS 943 | AS 944 | AS 944 LL | AS 946 | AS 963 |
| MISCELLANEOUS | | | | | | | | | | | | | | | | |
|  | 801252083 | Scooter m/d head tool for 8" rims (up to serial #MRC197167) | | ★ | ★ | ★ | ★ | ★ | ★ | ★ | ★ | ★ | ★ | ★ | ★ | ★ |
|  | 8-11120027 | Universal motorcycle bead breaker blade | | ★ | ★ | ★ | ★ | ★ | ★ | ★ | ★ | ★ | ★ | ★ | ★ | ★ |
|  | 8-11100028 | Mounting tool for rims with projected spokes | ★ | ★ | ★ | ★ | ★ | ★ | ★ | ★ | ★ | ★ | ★ | ★ | ★ | ★ |
|  | 8-11100001 | M/D head tool fast fitting kit (up to serial #MRC197167) | | ★ | ★ | ★ | ★ | ★ | ★ | ★ | ★ | ★ | ★ | ★ | ★ | ★ |
|  | 8-11120089 | Kit quick change tool head (starting from serial # MRC197168) | ★ | ★ | ★ | ★ | ★ | ★ | ★ | ★ | ★ | ★ | ★ | ★ | ★ | ★ |
|  | 801232202 | Large ring to hold kg 5 grease tank ø 185 mm | | | | ★ | ★ | ★ | ★ | ★ | ★ | ★ | ★ | ★ | ★ | ★ |
|  | 8-11100296 | Adjustment kit LL head tool | | | | | | | | | | | | | ★ | |
|  | 8-11120095 | Lube bracket 1-5 Kg | ★ | ★ | ★ | ★ | | ★ | ★ | ★ | ★ | ★ | ★ | ★ | ★ | ★ |
|  | 8-11120092 | Storage tray | ★ | ★ | ★ | ★ | ★ | ★ | ★ | ★ | ★ | ★ | ★ | ★ | ★ | ★ |

"WITHOUT LEVER" CAR TYRE CHANGERS

AQUILA AS944 LL

STANDARD ACCESSORIES



| Part-no | Electrical Supply | Description |
|---------------|----------------------|---|
| 0-11110201/16 | 400V/3Ph/50Hz | AS944 LL |
| 0-11110302/16 | 230V/1Ph/50-60Hz | AS944 LL TI |
| 0-11110232/16 | 230V/1Ph/50-60Hz | AS944 LL 2V |
| 0-11110301/16 | 230V/1Ph/50-60Hz | AS944 LL TI 2V |
| 0-11110332/16 | 200-230V/1Ph/50-60Hz | AS944 LL TI 2V complete of SUPER RM EAGLE |
| 0-11110262/16 | 230V/1Ph/50-60Hz | AS944 LL 2V complete of SUPER RM EAGLE |
| 0-11110282/16 | 230V/1Ph/50-60Hz | AS944 LL 2V complete of SUPER RM NEW, RM2, RM3 and WDK kit |
| 0-11110382/16 | 200-230V/1Ph/50-60Hz | AS944 LL TI 2V MI complete of SUPER RM NEW, RM2, RM3 and WDK kit |

"WITHOUT LEVER" CAR TYRE CHANGERS

AQUILA AUDAX



12"-30"

STANDARD ACCESSORIES

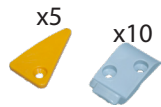
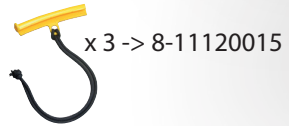
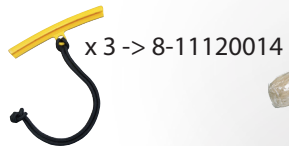

8-11400325



| Part-no | Electrical Supply | Description | |
|---------------|----------------------|------------------------------------|--|
| 0-15300102/16 | 200-230V/1Ph/50-60Hz | AQUILA AUDAX | |
| 0-15300132/16 | 200-230V/1Ph/50-60Hz | AQUILA AUDAX + wheel lifter | |

"WITHOUT LEVER" TYRE CHANGER

AQUILA RAPTOR



12"-28"

STANDARD ACCESSORIES



| Part-no | Electrical Supply | Description | |
|---------------|----------------------|---|--|
| 0-11108622/16 | 200-230V/1Ph/50-60Hz | AQUILA RAPTOR MI | |
| 0-11108632/16 | 200-230V/1Ph/50-60Hz | AQUILA RAPTOR MI + wheel lifter | |
| 0-11308652/16 | 200-230V/1Ph/50-60Hz | AQUILA RAPTOR MI + wheel lifter + Press Mate | |

"WITHOUT LEVER" TYRE CHANGER

AQUILA RAPAX



13"-28"

STANDARD ACCESSORIES



| Part-no | Electrical Supply | Description |
|---------------|----------------------|---|
| 0-11309012/16 | 200-230V/1Ph/50-60Hz | AQUILA RAPAX MI 2V + Press Mate |
| 0-11309032/16 | 200-230V/1Ph/50-60Hz | AQUILA RAPAX MI 2V + wheel lifter + Press Mate |

"WITHOUT LEVER" TYRE CHANGER

AQUILA TORNADO SERIES

NEW!



13"-32"

STANDARD ACCESSORIES



| Part-no | Electrical Supply | Description |
|---------------|----------------------|---|
| 0-11117375/16 | 200-230V/1Ph/50-60Hz | Aquila TORNADO START complete with Premium front wheel lifter and bead presser |
| 0-11117376/16 | 200-230V/1Ph/50-60Hz | Aquila TORNADO VISION complete with Premium front wheel lifter, bead presser and camera |
| 0-11117377/16 | 200-230V/1Ph/50-60Hz | Aquila TORNADO VISION A complete with Premium front wheel lifter, bead presser, camera and automatic demounting cycle |
| 0-11117378/16 | 200-230V/1Ph/50-60Hz | Aquila TORNADO PLATINUM complete with Premium front wheel lifter, bead presser, camera, automatic demounting cycle and Inflatron |

"WITHOUT LEVER" TYRE CHANGER FOR SERVICE MOBILE

AQUILA AUDAX M







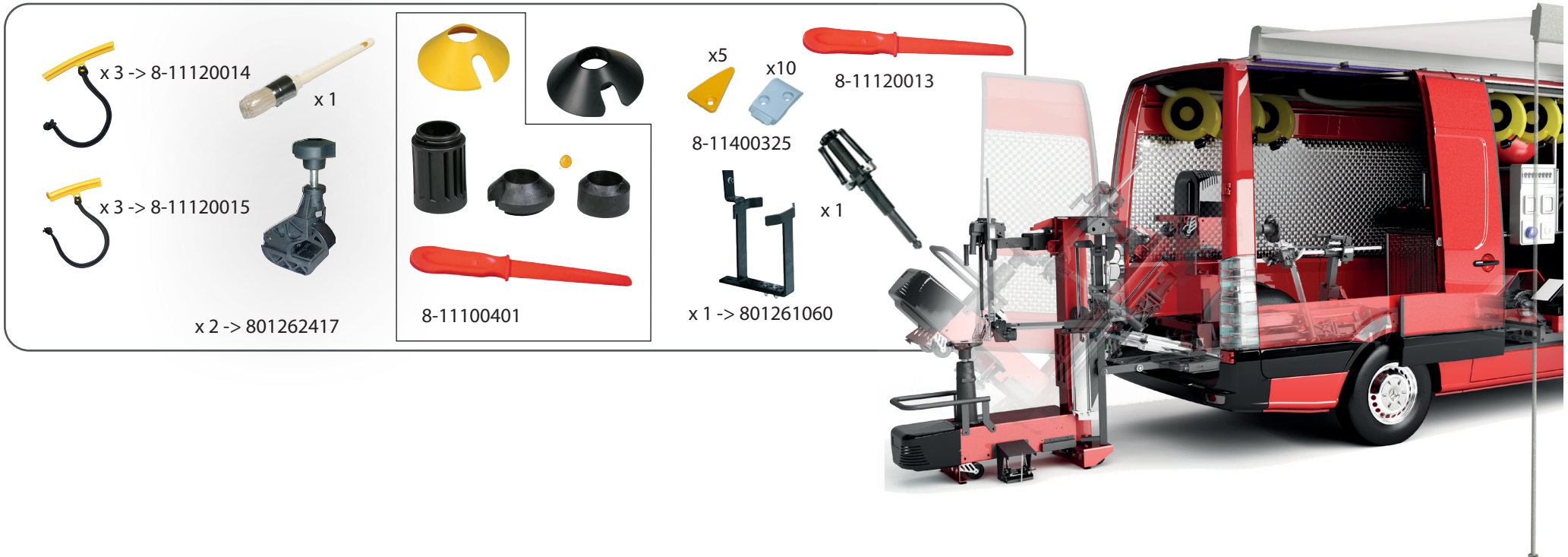

12"-30"

STANDARD ACCESSORIES

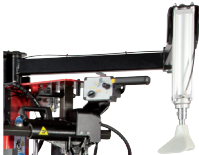

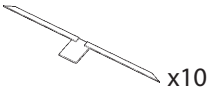





| Part-no | Electrical Supply | Description | |
|---------------|----------------------|---|--|
| 0-15300152/16 | 200-230V/1Ph/50-60Hz | AQUILA AUDAX M | |
| 8-51100038 | | Components for power unit (battery pack + battery charger, 48V-6Kw inverter, inverter 12V-1,5Kw, warning remote control inverter status, air reservoir, rotary compressor) | |







"WITHOUT LEVER" TYRE CHANGER ACCESSORIES

| Image | Part-no | Description | | RAPTOR | AUDAX | RAPAX | TORNADO |
|---|------------|---|--|--------|-------|-------|---------|
| BEAD PRESSING SYSTEMs | | | | | | | |
|  | 8-11100128 | Press Mate - Pneumatic bead pressing help device | | ★ | | | |
|  | 8-11100097 | Bead pressing tool | | | ★ | | |
|  | 8-11100338 | PAX System kit | | ★ | ★ | ★ | |
|  | 8-11100079 | PAX PSR Manual Extractor | | ★ | ★ | ★ | |
|  x10 | 801260235 | KIT REGLETTE Mounting strip for PAX System | | ★ | ★ | ★ | |
| CLAMPING ADAPTORS | | | | | | | |
|  | 8-11100037 | Kit for light commercial vehicles and pick-up rims. Rim hole diameter: max 180 mm AUTOMATIC LOCKING | | ★ | | ★ | ★ |
| | 8-11100086 | Kit for light commercial vehicles and pick-up rims. Rim hole diameter: max 180 mm MANUAL LOCKING | | | ★ | | |
|  | 8-15100003 | Special adapter kit for wide rims (H=28mm). Es. Porsche rear wheel | | | | ★ | ★ |
|  | 8-15100040 | H=22 mm Spacer ring to be combined with P/N 8-11100037 / 8-11100086 / 8-15100003 | | ★ | ★ | ★ | ★ |

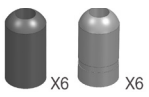

"WITHOUT LEVER" TYRE CHANGER ACCESSORIES

| Image | Part-no | Description | RAPTOR | AUDAX | RAPAX | TORNADO |
|---|------------|--|--------|-------|-------|---------|
|  | 8-15100041 | UNIVERSAL FLANGE ALL IN ONE H 100 MM + 20 MM SPACERS MIN-MAX WHEELBASE - PCD : 95-183 MM / 3.7"-7.2" | ★ | ★ | ★ | ★ |
|  | 8-15100049 | UNIVERSAL FLANGE "LARGE" H 100 mm + 20 mm spacers (min-max wheelbase - PCD: 135-226 mm / 53"-8.9") | ★ | ★ | ★ | ★ |
|  | 8-15100045 | LONG STEM KIT FOR UNIVERSAL FLANGE (6 pieces) (min-max wheelbase - PCD: 135-226 mm/53"-8.9") | ★ | ★ | ★ | ★ |
|  | 8-15100044 | 60 MM STUD BOLT KIT FOR UNIVERSAL FLANGE (6 pieces) H 60 mm / 2.36" stud bolts To be mounted on the universal flange in place of standard H 100 / 3.94" stud bolts. They can also be matched with H 20 / 0.8" spacers | ★ | ★ | ★ | ★ |
|  | 8-15100042 | PIN FOR MANUAL/ELECTRO-MECHANICAL LOCKING for universal flange To be mounted on the universal flange with CLOSED CENTRE rims | | ★ | | ★ |
|  | 8-15100043 | PIN KIT FOR PNEUMATIC LOCKING FOR UNIVERSAL FLANGE To be mounted on the universal flange with CLOSED CENTRE rims | ★ | | ★ | |



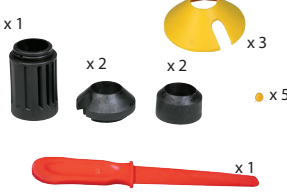
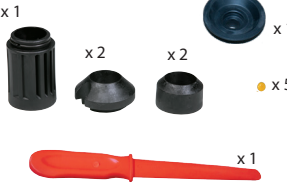

"WITHOUT LEVER" TYRE CHANGER ACCESSORIES

| Image | Part-no | Description | RAPTOR | AUDAX | RAPAX | TORNADO |
|---|------------|--|--------|-------|-------|---------|
|  | 8-15100046 | MANUAL LOCKING LONG HANDLE To be used with the universal flange and lock the rim through the wheel bolt holes | | ★ | | |
|  | 8-15100047 | PNEUMATIC LOCKING LONG HANDLE To be used with the universal flange and lock the rim through the wheel bolt holes | ★ | | ★ | |
|  | 8-15100048 | ELECTRO-MECHANICAL LOCKING LONG HANDLE To be used with the universal flange and lock the rim through the wheel bolt holes | | | | ★ |
|  | 8-11100244 | STANDARD STEMS + H 60 MM STUD BOLTS + H 20 MM SPACERS | ★ | ★ | ★ | ★ |
|  | 8-11100246 | STANDARD STEMS + H 100 MM STUD BOLTS + H 20 MM SPACERS | ★ | ★ | ★ | ★ |
|  | 8-11100291 | Set of 6 spherical extentions for new AUDI type rims | ★ | ★ | ★ | ★ |
|  | 8-11100284 | Set of 12 plastic guard for extensions | ★ | ★ | ★ | ★ |
|  | 8-11120013 | PTS - Tyre bead protector (red) | | □ | □ | □ |





"WITHOUT LEVER" TYRE CHANGER ACCESSORIES

| Image | Part-no | Description | | RAPTOR | AUDAX | RAPAX | TORNADO |
|---|------------|--|--|--------|-------|-------|---------|
|  | 8-11100400 | Manual locking Kit | | | ★ | | |
|  | 8-11100401 | Protections kit for automatic locking | | | ☐ | ☐ | |
|  | 8-11100412 | Pneumatic locking Kit | | | | | ☐ |
|  | 8-11400293 | Spare kit of leverless tool head plastic protections (up to serial number MMG143866) | | ★ | ☐ | | |
|  | 8-11400325 | Plastic protections kit for "without lever" V3 head tool (from serial number MMG143867) | | ★ | ☐ | | |



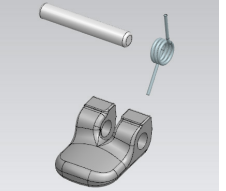

"WITHOUT LEVER" TYRE CHANGER ACCESSORIES

| Image | Part-no | Description | RAPTOR | AUDAX | RAPAX | TORNADO |
|---|------------|--|--------------------------|--------------------------|--------------------------|--------------------------|
|  | 8-11120014 | REP - 3 Rim edge plastic protections (yellow) | <input type="checkbox"/> | <input type="checkbox"/> | <input type="checkbox"/> | <input type="checkbox"/> |
|  | 8-11120015 | REPS - 3 Short rim edge plastic protections (yellow) | <input type="checkbox"/> | <input type="checkbox"/> | <input type="checkbox"/> | <input type="checkbox"/> |
|  | 8-11120058 | Plastic protection kit (5 pcs) for cone Ø 145 mm | ★ | | ★ | |
|  | 8-11100126 | 6 plastic protections for code 8-11100120 | ★ | ★ | ★ | <input type="checkbox"/> |



"WITHOUT LEVER" TYRE CHANGER ACCESSORIES

| Image | Part-no | Description | | RAPTOR | AUDAX | RAPAX | TORNADO |
|---|------------|---|--|--------|-------|-------|---------|
| PLASTIC PROTECTIONS | | | | | | | |
|  <p>x3</p> | 8-11120035 | KPUL Spare tool plastic protection kit | | | | ★ | ★ |
|  <p>x5 x5 x7</p> | 8-11120036 | TH - Protection tools kit | | | | ★ | ★ |
|  | 8-11120083 | Retractable lever kit (1 pc for each item) | | | | | ★ |
| MISCELLANEOUS | | | | | | | |
|  | 8-11100456 | MAT TC Mobile Accessories Trolley | | ★ | ★ | ★ | ★ |

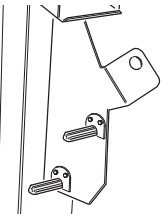
"WITHOUT LEVER" TYRE CHANGER ACCESSORIES

| Image | Part-no | Description | RAPTOR | AUDAX | RAPAX | TORNADO |
|---|------------|--|--------|-------|-------|---------|
| MISCELLANEOUS | | | | | | |
|  | 8-11100160 | Tubeless Inflation sytem | ★ | | | |
| | 8-11100111 | T.I. system kit | | ★ | | |
| | 8-11120053 | T.I. inflating system kit | | | ★ | |
| | 8-11120054 | T.I. Asme kit (For USA and Canada Only) | | | ★ | |
| | 8-11100404 | T.I. inflating system kit | | | | ★ |
| | 8-15100038 | T.I. Asme kit (For USA and Canada Only) | | | | ★ |
|  | 801435685 | Plastic clamp for STANDARD type alloy rims | ★ | ★ | ★ | |
|  | 8-11100120 | Sliding bead pressing clamp | ★ | ★ | ★ | □ |
|  | 801262417 | Plastic clamp for SOFT LINE type alloy rims | □ | □ | □ | □ |
|  | 8-11100159 | Support for accessories | ★ | | | |

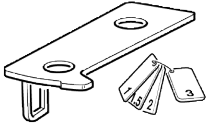
"WITHOUT LEVER" TYRE CHANGER ACCESSORIES

| Image | Part-no | Description | | RAPTOR | AUDAX | RAPAX | TORNADO |
|---|------------|--|--|--------|-------|-------|---------|
| MISCELLANEOUS | | | | | | | |
|  | 801261060 | Large ring to hold kg 3,5 - 5 grease tank | | | □ | | |
|  | 8-11100125 | Template kit for head tool adjustment | | | ★ | | |
|  | 8-11100166 | RFT Kit | | ★ | | | |
|  | 8-11120117 | Rectangular mirror with magnetic support | | ★ | ★ | ★ | ★ |

SEMI-AUTOMATIC HEAVY-DUTY TYRE CHANGER

TB120



14'' - 26''

STANDARD ACCESSORIES

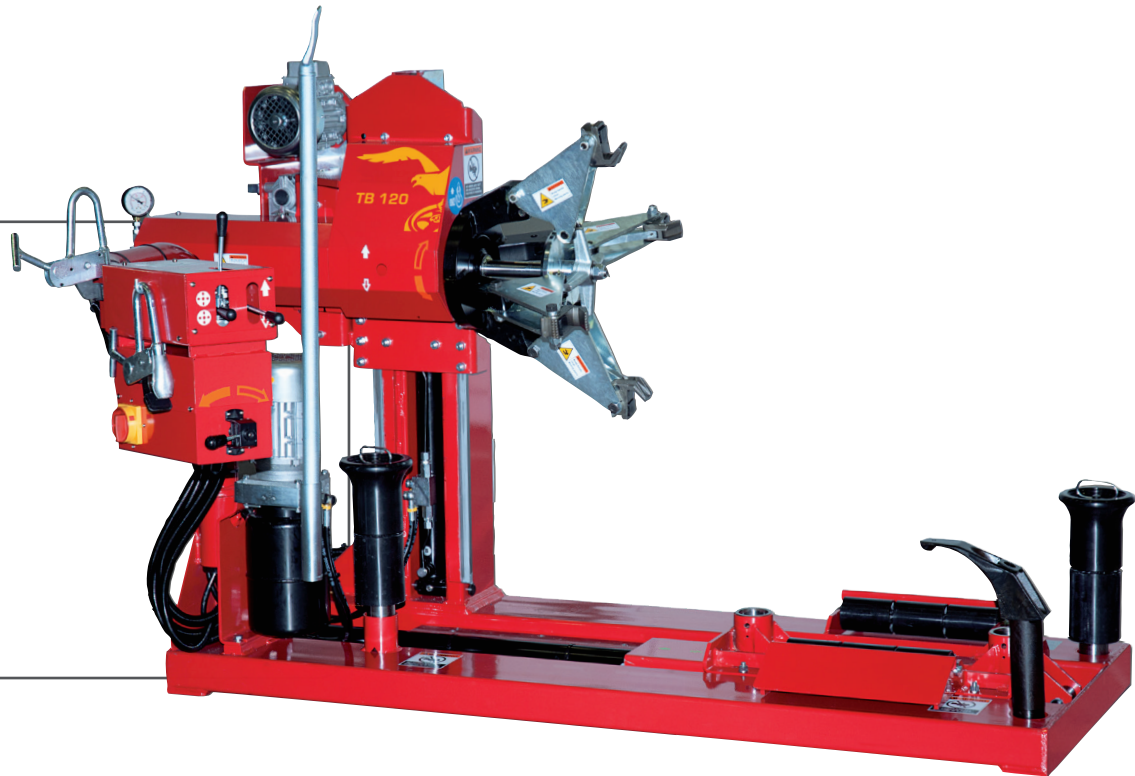
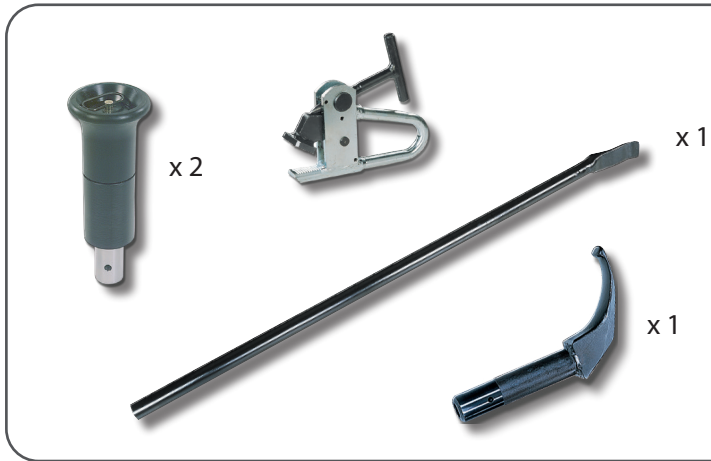

| Part-no | Electrical Supply | Description | |
|---------------|-------------------|--------------|--|
| 0-12302006/16 | 400V/3Ph/50Hz | TB120 | |
| 0-12302007/16 | 230V/3Ph/60Hz | TB120 | |
| 0-12302008/16 | 230V/1Ph/50Hz | TB120 | |
| 0-12302009/16 | 230V/1Ph/60Hz | TB120 | |

SEMI-AUTOMATIC HEAVY-DUTY TYRE CHANGER

TB125



14" - 26"

STANDARD ACCESSORIES

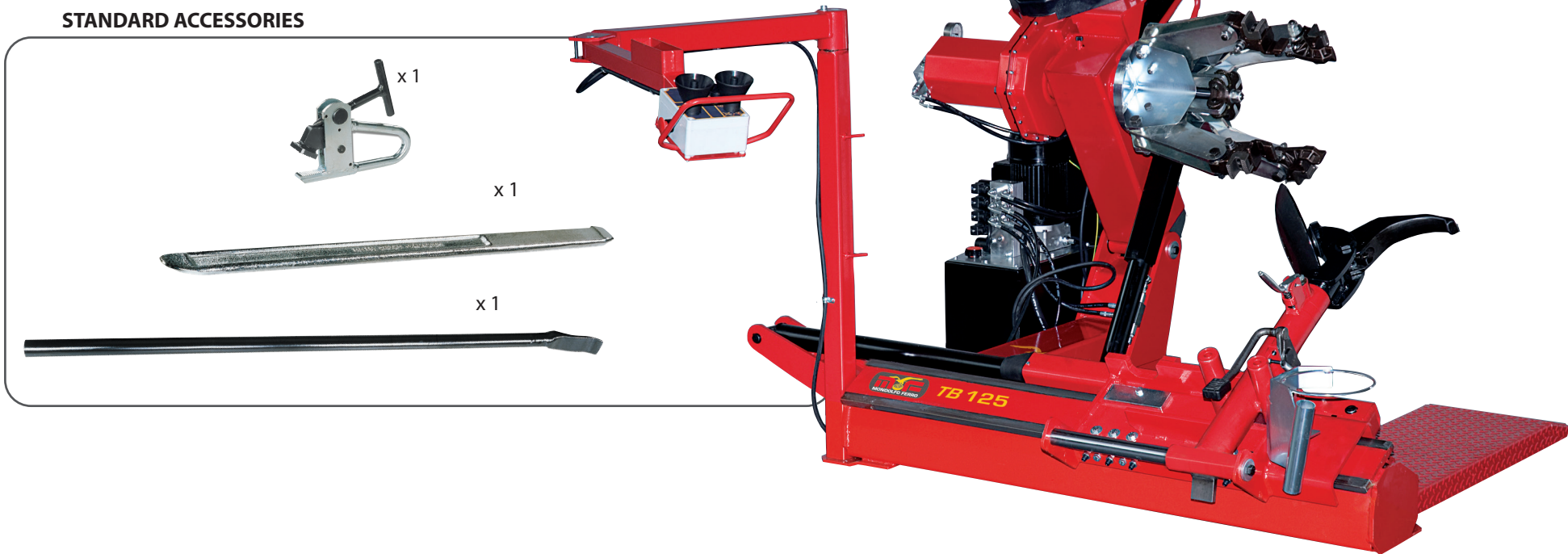

| Part-no | Electrical Supply | Description | |
|---------------|-------------------|---------------|--|
| 0-12300901/16 | 400V/3Ph/50Hz | TB 125 | |
| 0-12300902/16 | 230V/3Ph/50Hz | TB 125 | |
| 0-12300903/16 | 400V/3Ph/60Hz | TB 125 | |
| 0-12300904/16 | 230V/3Ph/60Hz | TB 125 | |
| 0-12300905/16 | 230V/1Ph/60Hz | TB 125 | |

SEMI-AUTOMATIC HEAVY-DUTY TYRE CHANGER

TB128 N



14''- 26''

STANDARD ACCESSORIES

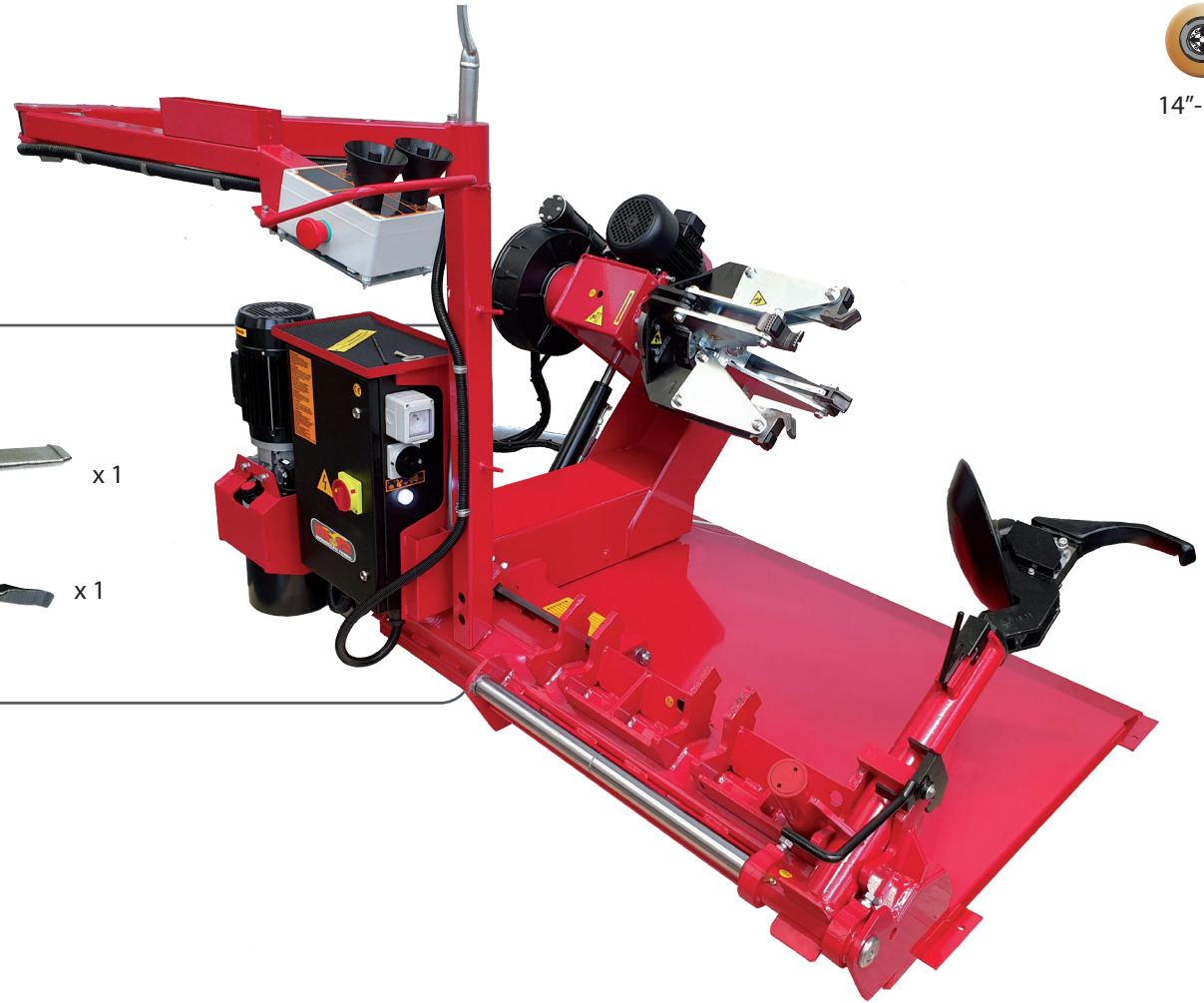
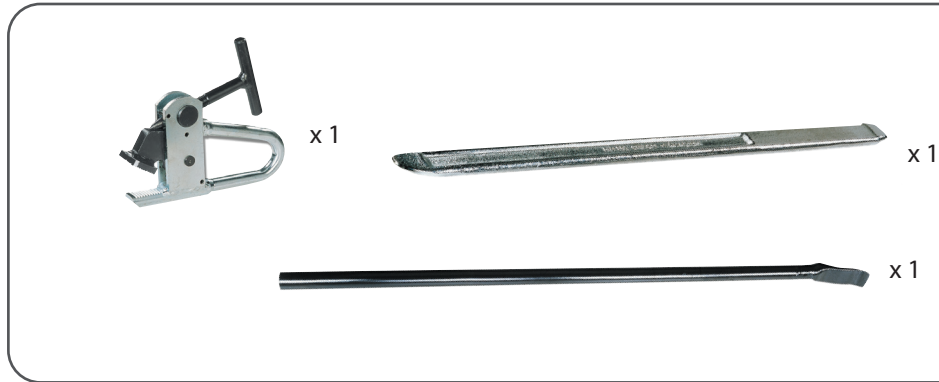

| Part-no | Electrical Supply | Description | |
|---------------|-------------------|-----------------------|--|
| 0-12302401/16 | 400V/3Ph/50Hz | TB 128 N | |
| 0-12302404/16 | 230V/3Ph/50-60Hz | TB 128 N | |
| 0-12302405/16 | 200V/3Ph/50-60Hz | TB 128 N JAPAN | |

SEMI-AUTOMATIC HEAVY-DUTY TYRE CHANGER

TBE 145 N



14" - 56"

STANDARD ACCESSORIES

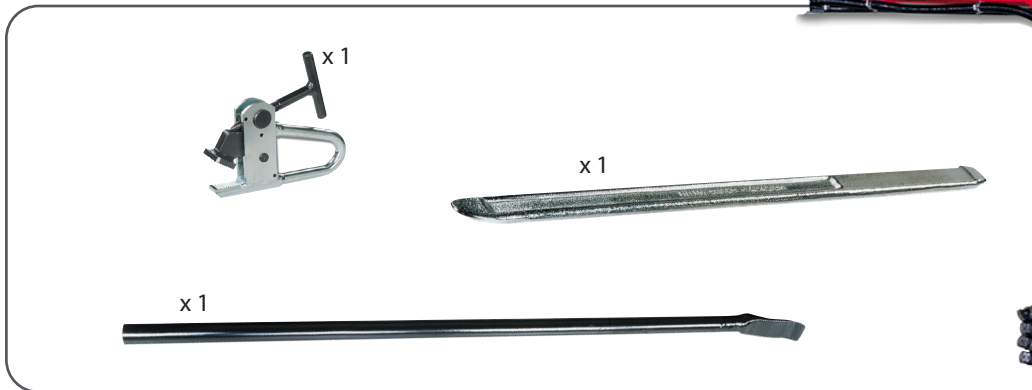

| Part-no | Electrical Supply | Description | |
|---------------|-------------------|--------------|--|
| 0-12305007/16 | 400V/3Ph/50Hz | TBE145 VAN N | |



NEW

SEMI-AUTOMATIC HEAVY-DUTY TYRE CHANGER

TBE155



14''-56''

STANDARD ACCESSORIES

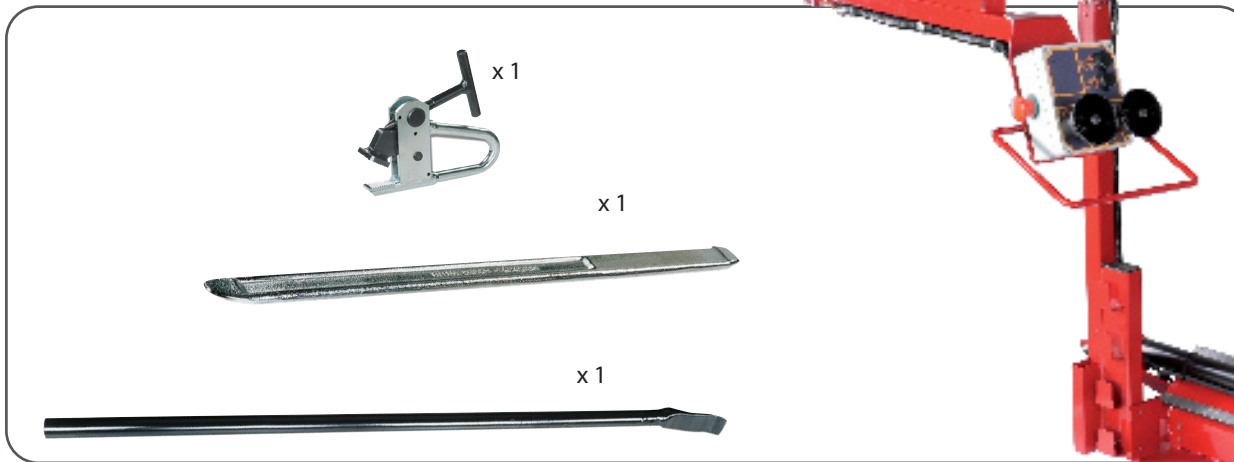

| Part-no | Electrical Supply | Description | |
|---------------|-------------------|--------------------------|--|
| 0-12304501/16 | 400V/3Ph/50Hz | TBE 155 | |
| 0-12304502/16 | 230V/3Ph/60Hz | TBE 155 | |
| 0-12304503/15 | 400V/3Ph/60Hz | TBE 155 | |
| 0-12304504/16 | 230V/3Ph/50Hz | TBE 155 | |
| 0-12304801/16 | 400V/3Ph/50Hz | TBE 155 - TROLLEY | |

SEMI-AUTOMATIC HEAVY-DUTY TYRE CHANGER

TBE156 N PRO



14" - 56"

STANDARD ACCESSORIES

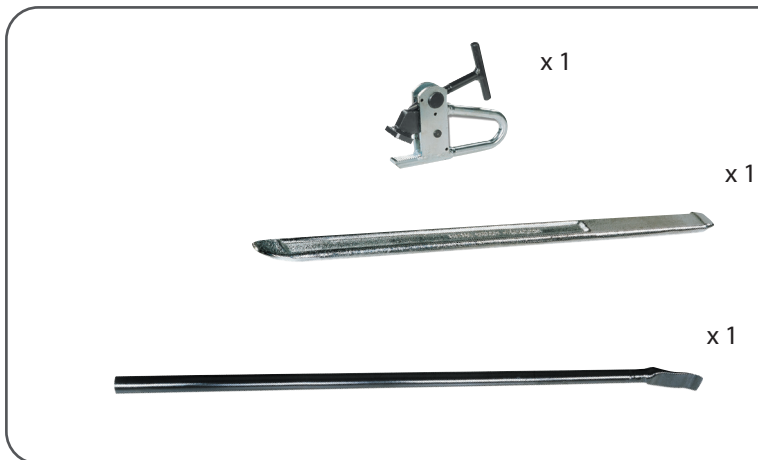

| Part-no | Electrical Supply | Description | |
|---------------|-------------------|---------------------------------|--|
| 12120101/16 | 400V/3Ph/50Hz | TBE 156 N PRO | |
| 12120201/16 | 230V/3Ph/50Hz | TBE 156 N PRO 1V | |
| 12120301/16 | 400V/3Ph/60Hz | TBE 156 N PRO | |
| 0-12301302/16 | 400V/3Ph/50Hz | TBE 156 N PRO 1V Trolley | |



NEW

AUTOMATIC HEAVY-DUTY TYRE CHANGER

TB128 DELUXE - SUPER



14"- 26"

STANDARD ACCESSORIES

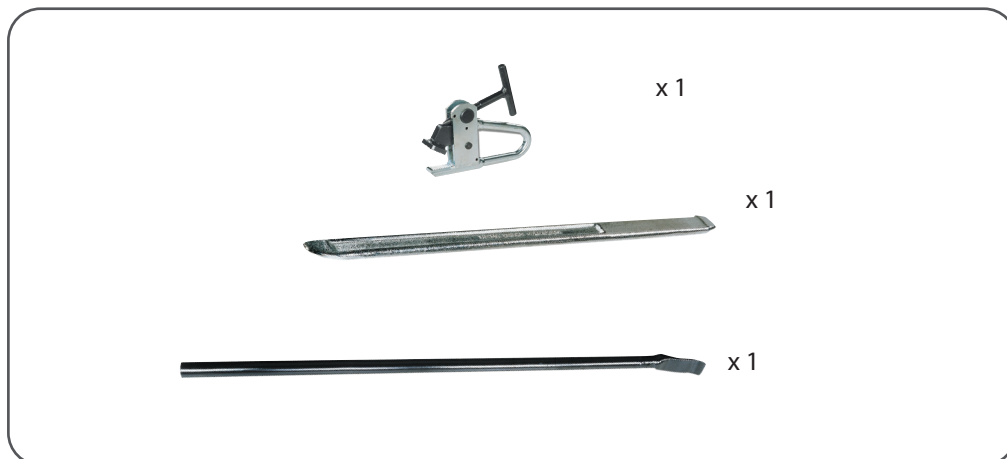

| Part-no | Electrical Supply | Description | |
|---------------|-------------------|----------------------------|--|
| 0-12302501/16 | 400V/3Ph/50Hz | TB 128 Deluxe | |
| 0-12302504/16 | 230V/3Ph/50-60Hz | TB 128 Deluxe | |
| 0-12302505/16 | 200V/3Ph/50-60Hz | TB 128 Deluxe Japan | |
| 0-12302601/16 | 400V/3Ph/50Hz | TB 128 Super | |
| 0-12302604/16 | 230V/3Ph/50-60Hz | TB 128 Super | |
| 0-12302605/16 | 200V/3Ph/50-60Hz | TB 128 Super Japan | |

AUTOMATIC HEAVY-DUTY TYRE CHANGER

TBE145 S



14" - 56"

STANDARD ACCESSORIES

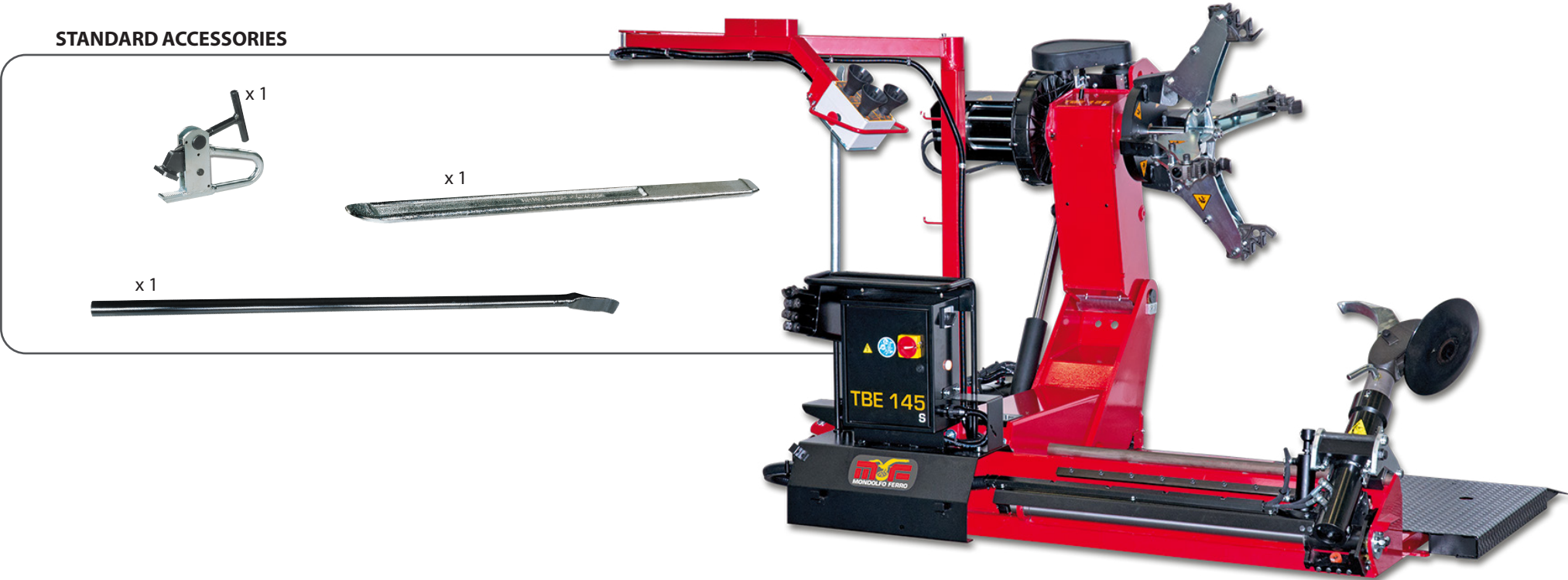

| Part-no | Electrical Supply | Description |
|---------------|-------------------|---------------------|
| 0-12305008/16 | 400V/3Ph/50Hz | TBE145 VAN S |



NEW

AUTOMATIC HEAVY-DUTY TYRE CHANGER

TBE155 S



14" - 56"

STANDARD ACCESSORIES

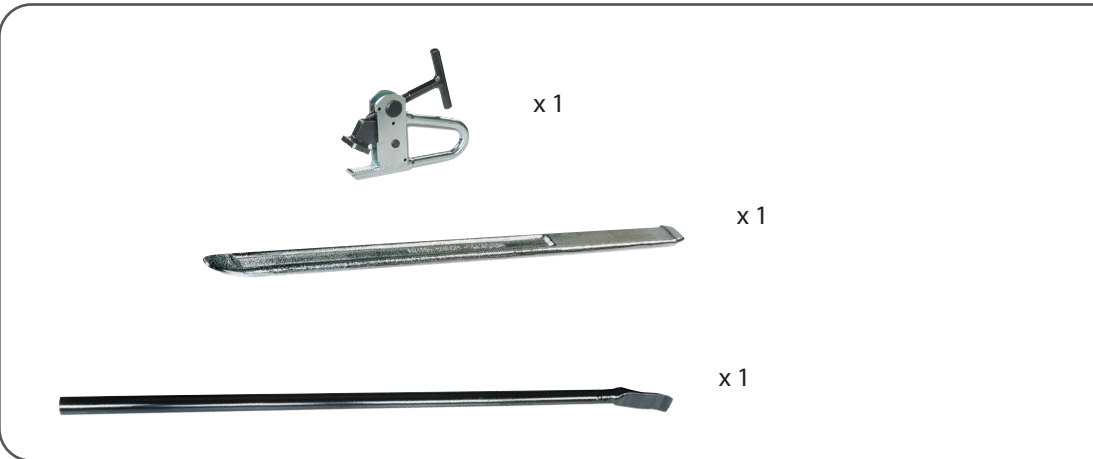

| Part-no | Electrical Supply | Description | |
|---------------|-------------------|-------------------|--|
| 0-12305001/16 | 400V/3Ph/50Hz | TBE 155 S | |
| 0-12305003/16 | 400V/3Ph/60Hz | TBE 155 S | |
| 0-12305002/16 | 230V/3Ph/50Hz | TBE 155 S | |
| 0-12305004/16 | 230V/3Ph/60Hz | TBE 155 S | |
| 0-12305006/16 | 230V/3Ph/60Hz | TBE 155 S TROLLEY | |



NEW

AUTOMATIC HEAVY-DUTY TYRE CHANGER

TBE156 DELUXE-S PRO



14" - 56"

STANDARD ACCESSORIES



| Part-no | Electrical Supply | Description | |
|---------------|-------------------|--|--|
| 12140601/16 | 400V/3Ph/50Hz | TBE 156 PRO DELUXE 2V | |
| 12143601/16 | 200V/3Ph/60Hz | TBE 156 PRO DELUXE 2V JAPAN | |
| 12130201/16 | 230V/3Ph/50Hz | TBE 156 S PRO 2V | |
| 12130601/16 | 400V/3Ph/50Hz | TBE 156 S PRO 2V | |
| 12130202/16 | 230V/3Ph/60Hz | TBE 156 S PRO 2V | |
| 0-12301301/16 | 400V/3Ph/50Hz | TBE 156 S PRO 2V Trolley | |
| 8-12100026 | | Radio kit for TBE 156 S PRO Trolley | |

AUTOMATIC HEAVY-DUTY TYRE CHANGER

TBE160 TERRA



14''- 60''

STANDARD ACCESSORIES

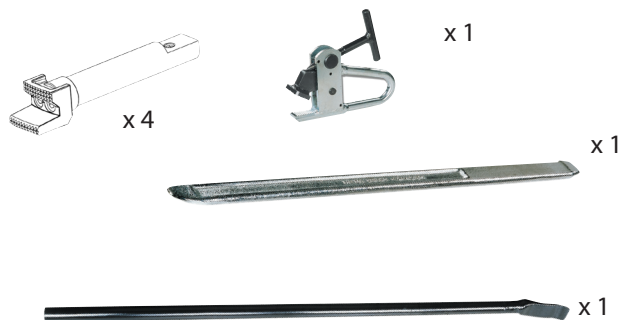

| Part-no | Electrical Supply | Description | |
|---------------|-----------------------|--|--|
| 0-12300701/16 | 400V/3Ph/50Hz | TBE 160 TERRA | |
| 0-12300703/16 | 400V/3Ph/60Hz | TBE 160 TERRA | |
| 0-12300702/16 | 200-208-230V/3Ph/50Hz | TBE 160 TERRA | |
| 0-12300704/16 | 200-208-230V/3Ph/60Hz | TBE 160 TERRA | |
| 0-12300706/16 | 400V/3Ph/50Hz | TBE 160 TERRA T - TROLLEY - | |
| 0-12300708/16 | 400V/3Ph/60Hz | TBE 160 TERRA T - TROLLEY - | |
| 0-12300707/16 | 200-208-230V/3Ph/50Hz | TBE 160 TERRA T - TROLLEY - | |
| 0-12300709/16 | 200-208-230V/3Ph/60Hz | TBE 160 TERRA T - TROLLEY - | |
| 8-12300006 | | RADIO kit for TBE 160 TERRA T Trolley | |

AUTOMATIC HEAVY-DUTY TYRE CHANGER

TBE60 TERRA



14'' - 60''

STANDARD ACCESSORIES



| Part-no | Electrical Supply | Description | |
|---------------|-------------------|----------------------|--|
| 0-12302101/16 | 400V/3Ph/50Hz | TBE 60 TERRA | |
| 0-12302102/16 | 230V/3Ph/60Hz | TBE 60 TERRA | |
| 0-12302103/16 | 400V/3Ph/60Hz | TBE 60 TERRA | |
| 0-12302105/16 | 400V/3Ph/50Hz | TBE 60 TERRA TROLLEY | |
| 0-12302108/16 | 230V/3Ph/60Hz | TBE 60 TERRA TROLLEY | |
| 0-12302109/16 | 400V/3Ph/60Hz | TBE 60 TERRA TROLLEY | |



NEW

SUPER AUTOMATIC "WITHOUT LEVER" HEAVY-DUTY TYRE CHANGERS

TBE160 MATIC



14''-60''

STANDARD ACCESSORIES

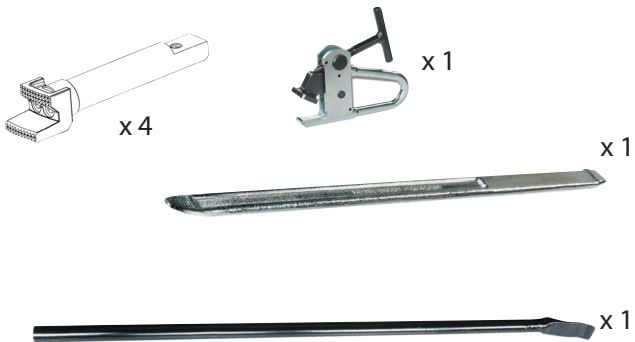

| Part-no | Electrical Supply | Description | |
|---------------|-----------------------|------------------------------------|--|
| 0-12300801/16 | 400V/3Ph/50Hz | TBE 160 MATIC | |
| 0-12300802/16 | 200-208-230V/3Ph/50Hz | TBE 160 MATIC | |
| 0-12300803/16 | 400V/3Ph/60Hz | TBE 160 MATIC | |
| 0-12300804/16 | 200-208-230V/3Ph/60Hz | TBE 160 MATIC | |
| 0-12300806/16 | 400V/3Ph/50Hz | TBE 160 MATIC T - TROLLEY - | |
| 0-12300807/16 | 200-208-230V/3Ph/50Hz | TBE 160 MATIC T - TROLLEY - | |
| 0-12300808/16 | 400V/3Ph/60Hz | TBE 160 MATIC T - TROLLEY - | |
| 0-12300809/16 | 200-208-230V/3Ph/60Hz | TBE 160 MATIC T - TROLLEY - | |

HEAVY-DUTY TYRE CHANGER FOR MOBILE SERVICE

TB124 MOBILE TB124 MOBILE HY



13"-26"

STANDARD ACCESSORIES

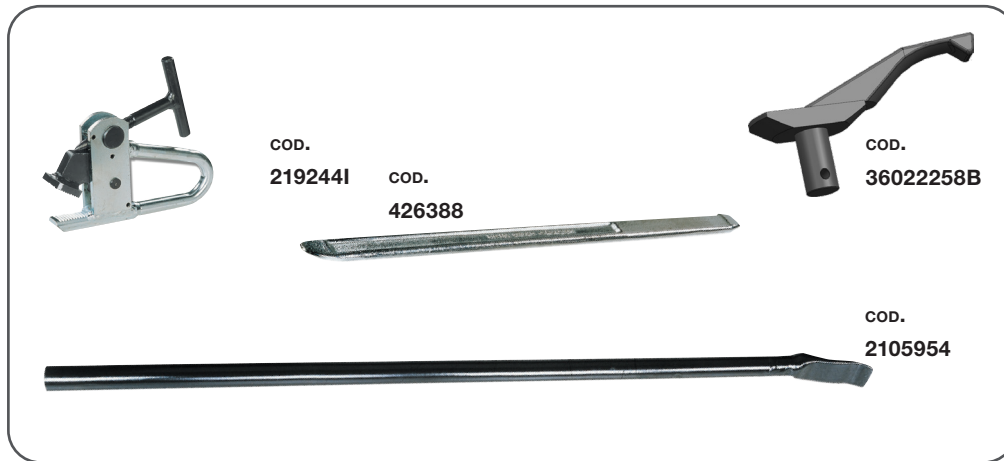

NEW!

| Part-no | Electrical Supply | Description | |
|---------------|-----------------------------|---|--|
| 0-12302301/16 | 380-400V/3Ph/50Hz | TB 124 MOBILE Truck mobile workshop complete with tyre changer + generator | |
| 0-12302201/16 | 380-400V/3Ph/50Hz | TB 124 MOBILE Truck mobile workshop complete with tyre changer without generator | |
| 0-12302901/16 | hydraulic and diesel engine | TB 124 MOBILE HY Truck mobile workshop complete with tyre changer + generator | |
| 0-12302911/16 | hydraulic and diesel engine | TB 124 MOBILE HY RS Truck mobile reverse workshop complete with tyre changer + generator | |

HEAVY-DUTY TYRE CHANGER FOR MOBILE SERVICE

TB123 MOBILE



13"-26"

STANDARD ACCESSORIES



| Part-no | Electrical Supply | Description | |
|---------------|-------------------|--|--|
| 0-12101901/16 | 380V/3Ph/50Hz | TB 123 Mobile with Generator | |
| 8-12100140 | | Compulsory sticker | |
| 0-12102201/16 | 380V/3Ph/50Hz | TB 123 Mobile without Generator | |
| 8-12100140 | | Compulsory sticker | |

MILITARY VEHICLE MAINTENANCE EQUIPMENT

TMW 20 S



14"-26"

STANDARD ACCESSORIES







NEW!

| Part-no | Electrical Supply | Description |
|---------------|-------------------|--|
| 0-12150001/90 | | TMW 20 S Military wheel system |
| 8-12300010/16 | | Customization kit for TMW 20 S compulsory |



NEW



ACCESSORIES FOR HEAVY-DUTY TYRE CHANGERS

| Image | Part-no | Description | TB 125 | TB 128 N-S-DL | TBE 145 Van S/N | TBE 155 | TBE 156 PRO N/DL/S | TBE 155 SUPER | TB 120 | TBE 160 Matic | TBE 160 Terra | TBE 60 Terra | TB 124 Mobile HY / Mobile RS | TB 124 Mobile | TB 123 Mobile |
|---|------------|--|--------|---------------|-----------------|---------|--------------------|---------------|--------|---------------|---------------|--------------|------------------------------|---------------|---------------|
| BEAD DEPRESSOR | | | | | | | | | | | | | | | |
|  | 0-12300201 | DM 120 - Bead pressure device for truck, bus and E.M. tyres | ★ | ★ | ★ | ★ | ★ | ★ | ★ | ★ | ★ | ★ | | | |
| TUBELESS ROLLER | | | | | | | | | | | | | | | |
|  steel | 19120014 | RT - Iron Tubeless roller | | | | | ★ | | | | | | | | |
|  Plastic | 19120017 | RT - Tubeless roller | | | | | | | | | | | | | |
| | 19120016 | RT - Tubeless roller for TB 126 N | | | | | ★ | | | | | | | | |
| | 19120018 | RT - Tubeless roller for TB 126 Deluxe / Super | | ★ | | | | | | | | | | | |
|  in acciaio/steel | 2306040C | RT - Tubeless tyre roller for truck and bus wheels | ★ | | | ★ | | | | | | | | | |
|  | 801289439 | BBR - Tubeless roller | | | | | | | | | | ★ | | | |







ACCESSORIES FOR HEAVY-DUTY TYRE CHANGERS

| Image | Part-no | Description | TB 125 | TB 128 N-S-DL | TBE 145 Van S/N | TBE 155 | TBE 156 PRO N/DL/S | TBE 155 SUPER | TB 120 | TBE 160 Matic | TBE 160 Terra | TBE 60 Terra | TB 124 Mobile HY / Mobile RS | TB 124 Mobile | TB 123 Mobile |
|---|------------|---|--------|---------------|-----------------|---------|--------------------|---------------|--------|---------------|---------------|--------------|------------------------------|---------------|---------------|
| PROTECTION RING | | | | | | | | | | | | | | | |
|  | 8-12100007 | TRAP 161 - Protection for truck alloy rims: ring diameter ø 161 mm | ★ | ★ | ★ | ★ | ★ | ★ | ★ | ★ | ★ | ★ | ★ | ★ | ★ |
| | 8-12100008 | TRAP 202 - Protection for truck alloy rims: ring diameter ø 202 mm | ★ | ★ | ★ | ★ | ★ | ★ | ★ | ★ | ★ | ★ | ★ | ★ | ★ |
| | 8-12100009 | TRAP 221 - Protection for truck alloy rims: ring diameter ø 221 mm | ★ | ★ | ★ | ★ | ★ | ★ | ★ | ★ | ★ | ★ | ★ | ★ | ★ |
| | 8-12100010 | TRAP 281 - Protection for truck alloy rims: ring diameter ø 281 mm | ★ | ★ | ★ | ★ | ★ | ★ | ★ | ★ | ★ | ★ | ★ | ★ | ★ |
| | 8-12100005 | TRAP 164 - Protection for truck alloy rims: ring diameter ø 164 mm | ★ | ★ | ★ | ★ | ★ | ★ | ★ | ★ | ★ | ★ | ★ | ★ | ★ |
| | 8-12100006 | TRAP 176 - Protection for truck alloy rims: ring diameter ø 176 mm | ★ | ★ | ★ | ★ | ★ | ★ | ★ | ★ | ★ | ★ | ★ | ★ | ★ |
| | 8-12300001 | TRAP 220 - Protection for truck alloy rims: ring diameter ø 220,1 mm for Alcoa wheels | ★ | ★ | ★ | ★ | ★ | ★ | ★ | ★ | ★ | ★ | ★ | ★ | ★ |

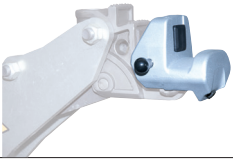

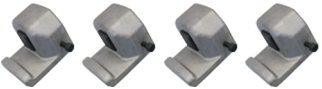
ACCESSORIES FOR HEAVY-DUTY TYRE CHANGERS

| Image | Part-no | Description | | TB 125 | TB 128 N-S-DL | TBE 145 Van S/N | TBE 155 | TBE 156 PRO N/DL/S | TBE 155 SUPER | TB 120 | TBE 160 Matic | TBE 160 Terra | TBE 60 Terra | TB 124 Mobile HY / Mobile RS | TB 124 Mobile | TB 123 Mobile |
|---|-----------|---|--|--------|---------------|-----------------|---------|--------------------|---------------|--------|---------------|---------------|--------------|------------------------------|---------------|---------------|
| CLAMPS | | | | | | | | | | | | | | | | |
|  | 801227195 | Wheel clamp for truck and bus alloy rims | | ★ | ★ | ★ | ★ | ★ | ★ | ★ | ★ | ★ | ★ | | | ★ |
|  | 801224201 | Longer rim clamp for big tyre mounting | | | | ★ | ★ | ★ | ★ | | ★ | ★ | ★ | | | |
|  | 801251904 | Skidder clamp | | | | ★ | ★ | ★ | ★ | | ★ | ★ | ★ | | | |



ACCESSORIES FOR HEAVY-DUTY TYRE CHANGERS

| Image | Part-no | Description | TB 125 | TB 128 N-S-DL | TBE 145 Van S/N | TBE 155 | TBE 156 PRO N/DL/S | TBE 155 SUPER | TB 120 | TBE 160 Matic | TBE 160 Terra | TBE 60 Terra | TB 124 Mobile HY / Mobile RS | TB 124 Mobile | TB 123 Mobile |
|---|------------|--|--------|---------------|-----------------|---------|--------------------|---------------|--------|---------------|---------------|--------------|------------------------------|---------------|---------------|
| JAW ACCESSORIES | | | | | | | | | | | | | | | |
|  | 8-12100175 | KGL56 - Set of 4 protections for ally rims | | | ★ | | ★ | ★ | | ★ | ★ | ★ | | | |
|  | 801254494 | Set of 4 aluminium protections for alloy rims, for TB120 up to serial no. MRD300913K | | ★ | | | | | ★ | | | | ★ | ★ | |
|  | 8-12100156 | GL - Kit of 4 alloy wheel clamps - 4V (the plastic insert accessory 8-11400200 may still be used with these clamps) for TBE120 starting from serial number MRD300914K | ★ | | | ★ | | | ★ | | | | | | |
|  | 8-11400200 | SPI - Special spare plastic inserts for GL | ★ | | | ★ | | | | | | | | | |
|  | 8-12100172 | SPIG - Kit of 8+8 CLAMP inserts | ★ | | | ★ | | | | | | | | | |
|  | 8-12100171 | P4P - Four points extensions for rims with circler | | | ★ | | ★ | ★ | | ★ | ★ | ★ | | | |





ACCESSORIES FOR HEAVY-DUTY TYRE CHANGERS

| Image | Part-no | Description | | TB 125 | TB 128 N-S-DL | TBE 145 Van S/N | TBE 155 | TBE 156 PRO N/DL/S | TBE 155 SUPER | TB 120 | TBE 160 Matic | TBE 160 Terra | TBE 60 Terra | TB 124 Mobile HY / Mobile RS | TB 124 Mobile | TB 123 Mobile |
|--|------------|--|--|--------|---------------|-----------------|---------|--------------------|---------------|--------|---------------|---------------|--------------|------------------------------|---------------|---------------|
| JAW ACCESSORIES | | | | | | | | | | | | | | | | |
|  <p>x 4</p> | 8-12100155 | PA - Kit of 4 SELF-CENTRING EXTENSIONS | | | | | ★ | | | | | | | | | |
|  | 8-12100176 | PA26 Set of 4 chuck extensions - 4v up to serial number MRE300446 | | | ★ | | | | | ★ | | | | ★ | ★ | |
|  | 8-12100188 | Extensions kit for port crane rims | | | | | | ★ | | | ★ | ★ | ★ | | | |





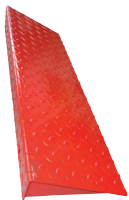
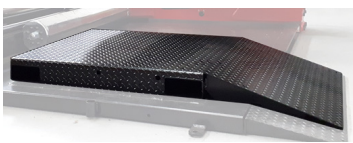

ACCESSORIES FOR HEAVY-DUTY TYRE CHANGERS

| Image | Part-no | Description | | TB 125 | TB 128 N-S-DL | TBE 145 Van S/N | TBE 155 | TBE 156 PRO N/DL/S | TBE 155 SUPER | TB 120 | TBE 160 Matic | TBE 160 Terra | TBE 60 Terra | TB 124 Mobile HY / Mobile RS | TB 124 Mobile | TB 123 Mobile |
|---|---------------|--|--|--------|---------------|-----------------|---------|--------------------|---------------|--------|---------------|---------------|--------------|------------------------------|---------------|---------------|
| MISCELLANEOUS | | | | | | | | | | | | | | | | |
|  | 8-12100191 | Electricity and air generator for installation on truck bed. GMD23-21 | | | ★ | ★ | ★ | ★ | ★ | | | | | | | |
| NEW! | 8-12100050 | 125-hour service kit for models complete with generator | | | | | | | | | | | | ★ | ★ | |
| NEW! | 8-12100051 | 250-hour hydraulic service kit for models complete with generator | | | | | | | | | | | | ★ | ★ | |
| NEW! | 8-12100049 | 250-hour electric service kit for models complete with generator | | | | | | | | | | | | ★ | ★ | |
|  | 8-12120008/90 | CAR MATE for TB 124 Mobile | | | | | | | | | | | | ★ | ★ | |
|  | 8-12120011/90 | Roller conveyor for TB 124 Mobile | | | | | | | | | | | | ★ | ★ | |

ACCESSORIES FOR HEAVY-DUTY TYRE CHANGERS





| Image | Part-no | Description | | TB 125 | TB 128 N-S-DL | TBE 145 Van S/N | TBE 155 | TBE 156 PRO N/DL/S | TBE 155 SUPER | TB 120 | TBE 160 Matic | TBE 160 Terra | TBE 60 Terra | TB 124 Mobile HY / Mobile RS | TB 124 Mobile | TB 123 Mobile |
|---|---------------|--|--|--------|---------------|-----------------|---------|--------------------|---------------|--------|---------------|---------------|--------------|------------------------------|---------------|---------------|
| MISCELLANEOUS | | | | | | | | | | | | | | | | |
|  | 8-12120009 | Extension for loading threshold 750 mm - TB 124 Mobile | | | | | | | | | | | | | ★ | ★ |
| | 8-12120010 | Extension for loading threshold 1000 mm - TB 124 Mobile | | | | | | | | | | | | | ★ | ★ |
|  | 801289441 | BBD - Bead breaking disk | | | | | | | | ★ | | | | | | |
|  | 8-12100030 | Bead breaker disc | | | | | | | | | | | | ★ | ★ | ★ |
|  | 8-12100039/16 | Horizontal charriot platform . | | | | | | | | | ★ | | | | | |
|  | 8-12100040/16 | Side chassis platform . | | | | | | | | | ★ | | | | | |
|  | 8-12120023/90 | Runway platform H110 | | | | | | | | | | | ★ | | | |

ACCESSORIES FOR HEAVY-DUTY TYRE CHANGERS

| Image | Part-no | Description | | TB 125 | TB 128 N-S-DL | TBE 145 Van S/N | TBE 155 | TBE 156 PRO N/DL/S | TBE 155 SUPER | TB 120 | TBE 160 Matic | TBE 160 Terra | TBE 60 Terra | TB 124 Mobile HY / Mobile RS | TB 124 Mobile | TB 123 Mobile |
|---|---------------|---|--|--------|---------------|-----------------|---------|--------------------|---------------|--------|---------------|---------------|--------------|------------------------------|---------------|---------------|
| MISCELLANEOUS | | | | | | | | | | | | | | | | |
|  | 8-12120026/16 | Platform for TBE128S | | | ★ | | | | | | | | | | | |
|  | 8-12300008 | Pedal kit for tyre retreading operations | | | | | | | | | ★ | ★ | | | | |
|  | 8-12300006 | Radio trolley Kit | | | | | | | | | | ★ | | | | |
|  | 8-12120020 | Kit Radio wireless | | | | | | | | | | | | | ★ | |
|  | 8-12120044/00 | Kit Radio Mobile Hydro | | | | | | | | | | | | ★ | | |
|  | 8-12100026 | Radio kit for TBE 156 S PRO Trolley | | | | | ★ | | | | | | | | | |

NEW!

ACCESSORIES FOR HEAVY-DUTY TYRE CHANGERS

| Image | Part-no | Description | TB 125 | TB 128 N-S-DL | TBE 145 Van S/N | TBE 155 | TBE 156 PRO N/DL/S | TBE 155 SUPER | TB 120 | TBE 160 Matic | TBE 160 Terra | TBE 60 Terra | TB 124 Mobile HY / Mobile RS | TB 124 Mobile | TB 123 Mobile |
|--|---------------|--|--------|---------------|-----------------|---------|--------------------|---------------|--------|---------------|---------------|--------------|------------------------------|---------------|---------------|
| MISCELLANEOUS | | | | | | | | | | | | | | | |
|  | 8-12120025/00 | Radio Remote control kit for TBE155 | | | | ★ | | | | | | | | | |
|  | 801237171 | Locking pin for alloy rims | ★ | ★ | ★ | ★ | ★ | ★ | ★ | ★ | ★ | ★ | ★ | ★ | ★ |
|  | 8-12100037 | Kit clamps hole Ø 80 | | | ★ | | ★ | ★ | | ★ | ★ | | | | |
|  | 8-12100157 | Kit series 4 clamps and connecting rods | ★ | | | | | | | | | | | | |
| | 8-12100160 | Kit series 4 monobloc clamps | | | | ★ | | | | | | | | | |
|  | 8-12100044 | 3 rim edge plastic protections | ★ | ★ | ★ | ★ | ★ | ★ | ★ | ★ | ★ | ★ | ★ | ★ | ★ |
| NEW! | 8-12120048 | Inverter Kit 230V | | | | | | | | | | | ★ | | |
| NEW! | 8-12100131 | Grease bucket holder | ★ | ★ | ★ | ★ | ★ | ★ | ★ | ★ | ★ | ★ | ★ | ★ | ★ |

AUTOMOTIVE SERVICE EQUIPMENT



www.facebook.com/MONDOLFOFERROofficial/



<http://www.youtube.com/user/MondolfoFerro>

NEXION S.p.A.
Viale Dell'Industria, 20 - 61037 MONDOLFO (PU) ITALY
Tel. 0721.93671 - Telefax 0721.930232
info@mondolfoferro.it - www.mondolfoferro.it

